



Project _____
 Item # _____
 Quantity _____

Commercial Electric Round Food Warmers & Cookers/Warmers

Models: FW-7R250, FW-7R500, FW-11R250, FW-11R500

With highly efficient heating distribution, Winco's durable and reliable food warmers and cookers/warmers are workhorses that can endure the harshest kitchen environments.

Available in both 7Qt and 11Qt capacities.

Standard Features

- ◆ Insulated heating compartment for maximum efficiency
 - ◆ No-drip rim keeps serving area clean
 - ◆ ETL listed for electrical safety, conforms to UL-197 and CSA C22.2
 - ◆ ETL listed for sanitation, conforms to NSF-4
 - ◆ 120V ~ 50/60 Hz
-
- ◆ 11 QT overall dimensions: 12-1/2"L x 12-1/2"W x 9-5/8"H
 - ◆ inside dimensions: 10-1/4" diameter x 6-1/4" deep
-
- ◆ 7 Qt overall dimensions: 11"L x 11"W x 9-1/2"H
 - ◆ inside dimensions: 8-1/4" diameter x 6" deep
-
- ◆ One year parts and labor warranty

Models

ROUND FOOD COOKERS/WARMERS (Wet well use only)

HEATS UP TO 212°F (100°C)

FW-11R500 (11 Qt)

120V-50/60Hz, 1250W, 10.5A

FW-7R500 (7 Qt)

120V-50/60Hz, 1050W, 8.75A

ROUND FOOD WARMERS (Wet well use only)

3 SETTINGS: LOW = 140°F / MEDIUM = 170°F / HIGH = 200°F

FW-11R250 (11 Qt)

120V-50/60Hz, 750W, 6.25A

FW-7R250 (7 Qt)

120V-50/60Hz, 550W, 4.6A

Accessories

INSET PANS

INS-11.0M - 11 quart inset pan

INS-7.0M - 7 quart inset pan

ADAPTOR RING

FW11R-ADP - converts the 11Qt unit to accept round insert with 7 quart capacity.

Food Warmers

Food Cookers & Warmers



FW-7R250



FW-7R500



FW-11R250



FW-11R500



Winco®, DWL International Trading, LLC

www.wincous.com
 equipsales@wincous.com

East Coast: 65 Industrial Road, Lodi, NJ 07644
 Tel. 1.888.946.2682 | Fax: 1.888.946.2632

West Coast: 14950-14952 Valley View Avenue, La Mirada, CA 90638
 Tel. 1.888.946.2652 | Fax: 1.562.926.5678



Commercial Electric Round Food Warmers & Cookers/Warmers

Models: FW-7R250, FW-7R500, FW-11R250, FW-11R500

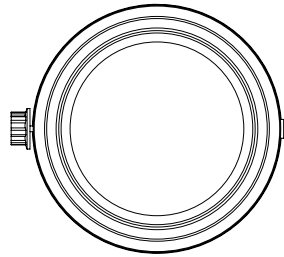

7Qt - TOP VIEW

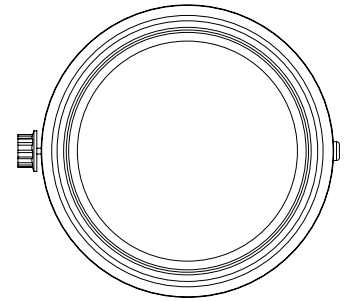

11Qt - TOP VIEW

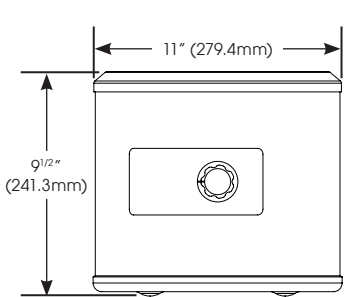

7Qt - FRONT VIEW

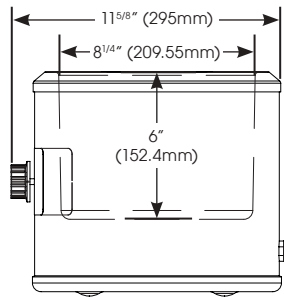

7Qt - SIDE VIEW

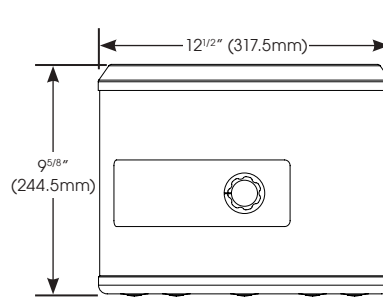

11Qt - FRONT VIEW

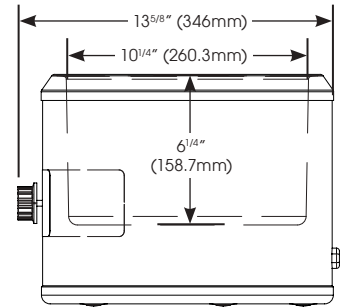

11Qt - SIDE VIEW

Specifications

MODEL	DESCRIPTION	LENGTH*	WIDTH*	HEIGHT	VOLTS	HZ	WATTS	AMPS	CORD	SHIP WEIGHT
FW-7R250	7Qt Round Food Warmer	11" (279.4mm)	11" (279.4mm)	9-1/2" (241.3mm)	120	50/60	550	4.6	14 A	9.77 lbs (4.43kgs)
FW-11R250	11Qt Round Food Warmer	12-1/2" (317.5mm)	12-1/2" (317.5mm)	9-5/8" (244.5mm)			750	6.25		12.57 lbs (5.7 kgs)
FW-7R500	7Qt Round Food Cooker/Warmer	11" (279.4mm)	11" (279.4mm)	9-1/2" (241.3mm)			1050	8.75	NEMA 5-15P	9.77 lbs (4.43kgs)
FW-11R500	11Qt Round Food Cooker/Warmer	12-1/2" (317.5mm)	12-1/2" (317.5mm)	9-5/8" (244.5mm)			1250	10.5		12.57 lbs (5.7 kgs)

*Length and width do not include control knob

Cord Location

Low and centered on back of unit

Plug Configuration

NEMA 5-15P

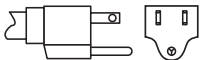

Product Specs

Commercial Electric Round Food Warmers & Cookers/Warmers

The Commercial Electric Round Food Warmers & Cookers/Warmers models FW-7R250, FW-11R250, FW-7R500, FW-11R500, manufactured by Winco®, Lodi, NJ 07644

The Commercial Electric Round Food Warmers & Cookers/Warmers shall be rated at 550 watts (FW-7R250) / 750 watts (FW-11R250) / 1050 watts (FW-7R500) / 1200 watts (FW-11R500). They shall consist of stainless steel housing, an insulated heating compartment, heating element, temperature control, no-drip rim, and an integral cord and plug.

Accessories may include inset pans and adaptor ring.

ETL listed for safety and sanitation in the US and Canada, conforms to UL-197 and CSA C22.2.

Warranty consists of one years parts and labor.

Winco®, DWL International Trading, LLC

www.wincous.com
equipsales@wincous.com

East Coast: 65 Industrial Road, Lodi, NJ 07644
Tel. 1.888.946.2682 | Fax: 1.888.946.2632

West Coast: 14950-14952 Valley View Avenue, La Mirada, CA 90638
Tel. 1.888.946.2652 | Fax: 1.562.926.5678