



## BUILT-IN UNDERCOUNTER COMMERCIAL DUAL-TAP BEER DISPENSERS (KEGERATORS)

**Solid Door Models:**  
SBC58BLBIADA  
SBC58BLCSSADA  
SBC58BLBIIFADA

**Glass Door Models:**  
SBC56GBIADA  
SBC56GBICSSADA  
SBC56GWBIADA



### Instruction Manual

**BEFORE USE, PLEASE READ AND FOLLOW  
ALL SAFETY RULES AND OPERATING INSTRUCTIONS**

**NOTE:** These units are designed for the cooling and dispensing of beer only, and are not recommended for storing perishable foods such as meats or dairy products.

Write Model and Serial Numbers here:

Model \_\_\_\_\_

Serial No. \_\_\_\_\_

**FELIX STORCH, INC.**  
Summit Appliance Division  
An ISO 9001:2015 registered company  
770 Garrison Avenue  
Bronx, New York  
[www.summitappliance.com](http://www.summitappliance.com)

# IMPORTANT SAFEGUARDS

**Your safety and the safety of others are very important.**

We have provided many important safety messages in this manual and on your appliance. Always read and obey all safety messages.



This is the Safety Alert Symbol. This symbol alerts you to potential hazards that can kill or injure you and others. All safety messages will follow the Safety Alert Symbol and either the words DANGER or WARNING.



DANGER means that failure to heed this safety statement may result in severe personal injury or death.



WARNING means that failure to heed this safety statement may result in extensive product damage, serious personal injury, or death.

Safety messages will alert you to what the potential hazard is, tell you how to reduce the chance of injury, and let you know what can happen if the instructions are not followed.

---



Before the kegerator is used, it must be properly positioned and installed as described in this manual, so read the manual carefully. To reduce the risk of fire, electrical shock or injury when using the appliance, follow basic precautions, including the following:



- Plug into a grounded 3-prong outlet. Do not remove grounding prong, do not use an adapter, and do not use an extension cord.
- It is recommended that a separate circuit, serving only your kegerator, be provided. Use receptacles that cannot be turned off by a switch or pull chain.
- Never clean appliance parts with flammable fluids. These fumes can create a fire hazard or explosion. And do not store or use gasoline or other flammable vapors and liquids in the vicinity of this or any other appliance. The fumes can create a fire hazard or explosion.
- Before proceeding with cleaning and maintenance operations, make sure the power line of the unit is disconnected.
- Do not connect or disconnect the electric plug when your hands are wet.
- Unplug the appliance or disconnect the power before cleaning or servicing. Failure to do so can result in electrical shock or death.
- Do not attempt to repair or replace any part of your kegerator unless it is specifically

recommended in this material. All other servicing should be referred to a qualified technician.



DANGER – RISK OF FIRE OR EXPLOSION. FLAMMABLE REFRIGERANT USED. TO BE REPAIRED BY TRAINED SERVICE PERSONNEL. DO NOT PUNCTURE REFRIGERANT TUBING.

These appliances are CFC- and HFC-free and contain a small quantity of Isobutane (R600a) which is environmentally friendly, but flammable. It does not damage the ozone layer, nor does it increase the greenhouse effect. Care must be taken during transportation and setting up of the appliance that no parts of the cooling system are damaged. Leaking coolant can ignite and may damage the eyes.

In the event of any damage:

- Avoid open flames and anything that creates a spark,
  - Disconnect from the electrical power line,
  - Air the room in which the appliance is located for several minutes and
  - Contact the Service Department for advice.
- The more coolant there is in an appliance, the larger the room it should be installed in. In the event of a leakage, if the appliance is in a small room, there is the danger of combustible gases building up. For every ounce of coolant at least 325 cubic feet of room space is required. The amount of coolant in the appliance is stated on the rating label. It is hazardous for anyone other than an Authorized Service Person to carry out servicing or repairs to this appliance.
  - Take serious care when handling, moving, and using the appliance to avoid either damaging the refrigerant tubing or increasing the risk of a leak.
  - Replacing component parts and servicing shall be done by factory authorized service personnel so as to minimize the risk of possible ignition due to incorrect parts or improper service.

## **WARNING**

- Use two or more people to move and install the appliance. Failure to do so can result in back or other injury.
- To ensure proper ventilation for your appliance, the front of the unit must be completely unobstructed. Choose a well-ventilated area with temperatures above 60 F (16 C) and below 90 F (32 C). This unit must be installed in an area protected from the elements, such as wind, rain, water spray or drips.
- The appliance should not be located next to ovens, radiators or other sources of high heat.
- The appliance must be installed with all electrical connections in accordance with state and local codes. A standard electrical supply (115V AC only, 60 Hz), properly grounded in accordance with the National Electrical Code and local codes and ordinances, is required.
- Do not kink or pinch the power supply cord of the appliance.
- The fuse (or circuit breaker) size should be 15 amperes.
- It is important for the kegerator to be leveled in order to work properly. You may need to make several adjustments to level it.
- Never allow children to operate, play with or crawl inside the kegerator.
- Do not use solvent-based cleaning agents or abrasives on the interior. These cleaners may damage or discolor the interior.
- Do not use this apparatus for other than its intended purpose.

*THESE MODELS ARE DESIGNED FOR COMMERCIAL USE.*

## **DANGER** *Risk of child entrapment*

Child entrapment and suffocation are not problems of the past. Junked or abandoned refrigerators and freezers are still dangerous, even if they will “just sit in the garage a few days.”

- **Before you throw away your old refrigerator or freezer:** Take off the doors. Leave the shelves or drawers in place so that children may not easily climb inside.

- Never allow children to operate, play with, or crawl inside the refrigerator/freezer.

*THIS APPLIANCE IS NOT INTENDED FOR USE BY YOUNG CHILDREN OR INFIRM PERSONS UNLESS THEY HAVE BEEN ADEQUATELY SUPERVISED BY A RESPONSIBLE PERSON TO ENSURE THAT THEY CAN USE THE APPLIANCE SAFELY. YOUNG CHILDREN SHOULD BE SUPERVISED TO ENSURE THAT THEY DO NOT PLAY WITH THE APPLIANCE.*

**– SAVE THESE INSTRUCTIONS –**

# Table of Contents

<b>Important Safeguards</b> .....	<b>1 - 2</b>
<b>Location of Parts</b> .....	<b>4</b>
<b>Technical Information</b> .....	<b>5</b>
<b>Installation Instructions</b> .....	<b>6 – 12</b>
<i>Parts List</i> .....	6
<i>Before Using Your Appliance</i> .....	6
<i>Installing the Kegerator</i> .....	6
<i>Electrical Connection</i> .....	7
<i>Extension Cord</i> .....	7
<i>Reversing the Door Swing</i> .....	8 – 9
<i>Adjusting the Tilt</i> .....	10
<i>Draft Arm Assembly</i> .....	10
<i>Beer Kegs and Keg Tappers</i> .....	10
<i>CO<sub>2</sub> Regulator and CO<sub>2</sub> Cylinder</i> .....	11
<i>Installation of Accessories</i> .....	11-12
<i>A Note about Freestanding Installation</i> .....	12
<b>Operating Your Kegerator</b> .....	<b>13</b>
<i>Temperature Control</i>	
<i>Defrosting</i>	
<b>Care and Maintenance</b> .....	<b>14</b>
<i>Cleaning Your Appliance / Power Failure / Vacations /</i>	
<i>Moving your Appliance / Energy-Saving Tips</i>	
<b>Draft Beer Troubleshooting</b> .....	<b>15 – 16</b>
<b>General Troubleshooting</b> .....	<b>17</b>
<b>Limited Warranty</b> .....	<b>19</b>

# Location of Parts

## Models SBC58BL and SBC58W Series



## Models SBC56G and SBC56GW Series

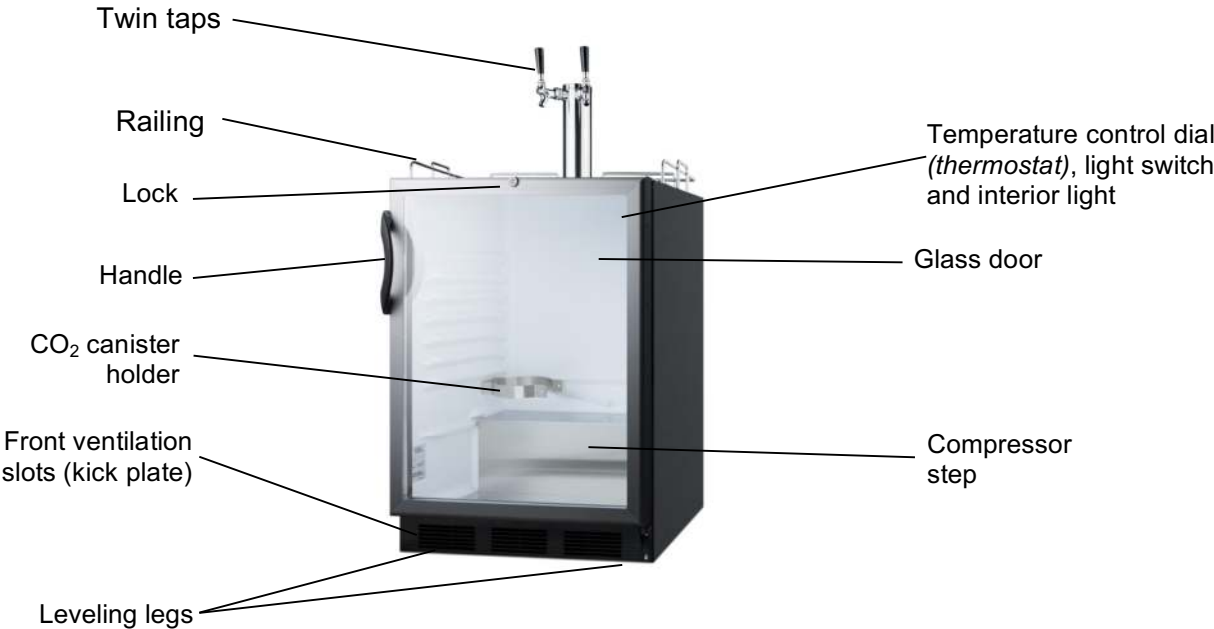

## Technical Information

<b>Model Numbers and Descriptions</b>	SBC58BLBIADA (reversible stainless steel door with horizontal handle, black cabinet) SBC58BLCSSADA (stainless steel cabinet and door [factory-reversible only], SS towel bar handle) SBC58BLBIIFADA (panel-ready door, factory-reversible only; handle provided by customer) SBC56GBIADA (reversible glass door, black cabinet) SBC56GBICSSADA (stainless steel-wrapped cabinet, SS towel bar handle, factory-reversible door only)
<b>Capacity</b>	Two 1/6 kegs
<b>Electrical Input</b>	115V AC/60Hz
<b>Rated Current</b>	SBC58BL models: 1.3A SBC56G models: 1.8A
<b>Defrost</b>	Automatic
<b>Refrigerant</b>	SBC58BL models: R600a (1.8 oz.)* SBC56G models: R600a (0.67 oz.)**
<b>Installation</b>	Built-in or free-standing
<b>Unit Dimensions (W x D x H)</b>	23.63" x 23.5" x 32" (32.25" to hinge cap)

*NOTES: Models with "NK" in the suffix do not include tapping equipment.  
All models are ETL-S listed to NSF-7 standards for commercial use.  
Specifications are subject to change without notice.*

**CALIFORNIA CARB/SNAP DISCLOSURE**

**This product uses eco-friendly hydrocarbon refrigerant and fully complies with California CARB regulations.**

However, we are required by California Law to provide the following disclosure statement in every product sold in California.

*"This equipment is prohibited from use in California with any refrigerants on the 'List of Prohibited Substances' for that specific end-use, in accordance with California Code of Regulations, title 17, section 95374. This disclosure statement has been reviewed and approved by Felix Storch, Inc. and Felix Storch, Inc. attests, under penalty of perjury, that these statements are true and accurate."*

This product does **not** use any refrigerants on the 'List of Prohibited Substances'"

# Installation Instructions

## Parts List

Remove all packing materials and parts. Inspect to make sure all parts listed below are present and in good condition:

- 1 double draft arm assembly (with washer)
- 1 CO<sub>2</sub> cylinder
- 1 CO<sub>2</sub> regulator
- 2 keg taps (American Sankey type)
- 1 cleaning kit
- Vinyl tubing
- 1 stainless steel (removable) floor to protect the unit during keg insertion
- 1 drip tray
- Hose clamps
- Various screws

## Before Using Your Appliance:

- Remove the exterior and interior packing.
- Before connecting the unit to a power source, let it stand for approximately 2 hours. This will reduce the possibility of a malfunction in the cooling system from handling during transportation.
- Clean the interior surfaces of the unit with lukewarm water using a soft cloth.

## Installing the Kegerator:

- Place the unit on a floor that is strong enough to support the appliance when it is fully loaded. To level the unit, adjust the two leveling legs at the front.
- Your appliance is designed to be either built-in or free-standing. Take care that the air vents at the front of the appliance are never covered or blocked in any way.
- Locate the unit away from direct sunlight and sources of heat (oven, heater, radiator, etc.). Direct sunlight may affect the acrylic coating and heat sources may increase electrical consumption. Extremely cold ambient temperatures may also affect the unit's performance.
- Avoid locating the unit in moist areas. Too much moisture in the air will cause frost to form quickly on the evaporator, requiring more frequent defrosting of the interior.
- Plug the unit into an exclusive, properly installed and grounded wall outlet. Do not under any circumstances cut or remove the third (ground) prong from the power cord. Any questions concerning power and/or grounding should be directed toward a certified electrician or authorized service center.

## **Electrical Connection:**

### **WARNING**

*Improper use of the grounded plug can result in the risk of electrical shock. If the power cord is damaged, have it replaced by the manufacturer, its service agent or similarly qualified persons in order to avoid a hazard.*

This unit should be properly grounded for your safety. The power cord of this unit is equipped with a three-prong plug which mates with a standard three-prong wall outlet to minimize the possibility of electrical shock.

Do not under any circumstances cut or remove the third ground prong from the power cord supplied. For personal safety, this appliance must be properly grounded.

This unit requires a standard 115-volt AC/60Hz electrical outlet with three-prong ground. Have the wall outlet and circuit checked by a qualified electrician to make sure the outlet is properly grounded. When a standard 2-prong wall outlet is encountered, it is your responsibility and obligation to have it replaced with a properly grounded 3-prong wall outlet.

To prevent accidental injury, the cord should be secured behind the unit and not left exposed or dangling.

The unit should always be plugged into its own individual electrical outlet which has a voltage rating that matches the rating label on the appliance. This provides the best performance and also prevents overloading house wiring circuits that could cause a fire hazard from overheated wires. Never unplug the unit by pulling on the power cord. Always grip the plug firmly and pull straight out from the receptacle. Repair or replace immediately any power cord that has become frayed or otherwise damaged. Do not use a cord that shows cracks or abrasion damage along its length or at either end. When moving the unit, be careful not to damage the power cord.

## **Extension Cord:**

Do not use an extension cord with this appliance. If the power cord is too short, have a qualified electrician or service technician install an outlet near the appliance.

## **Reversing the Door Swing**

If you find the direction of opening the door for either of the model series SBC58BL or SBC56G (excluding “CSS” and “IF” models) inconvenient, you can change it. Holes on the opposite side have already been prepared at the factory.

This appliance can be opened from either the right side or the left. By default, the door hinge is on the right side. If you prefer it on the left, please follow the appropriate instructions:

### **For SBC58BL models:**

1. Take off the upper hinge cover from the door and remove the screws that hold the top hinge.
2. Lift the hinge straight up to free the hinge pin from the socket in the top of the door.
3. Lift the door up and away to free its bottom socket from the hinge pin.
4. Remove the screws to the bottom hinge.
5. Remove the decorative caps from the opposite side and plug the holes from the original side with the decorative caps.
6. Move the bottom hinge to the opposite side and tighten the screws. Use any lock washers or nuts if they were installed in the original installation.
7. Replace door onto the hinge pin on the bottom hinge. Place top hinge pin into door. Insert screws into the top hinge and tighten.

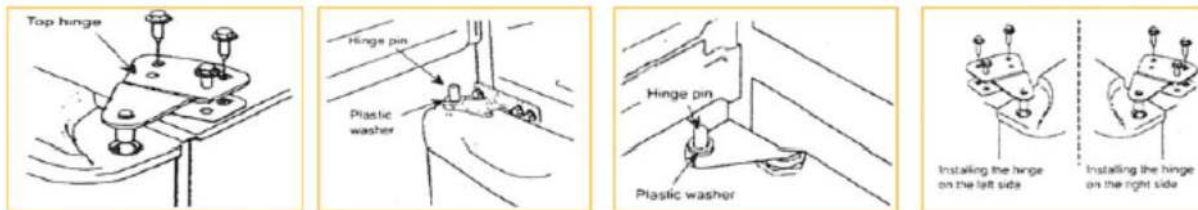

If you notice the door not hanging straight, loosen the top hinge screws, adjust the door until it is level and tighten the screws.

For SBC56G models:

*NOTES: See illustration below.*

*All of the parts that are removed must be kept for the reinstallation of the door.*

1. Unscrew the lower hinge and take off the door.
2. Push the kick plate to the right in the new position.
3. Undo the upper hinge fastener and fix it to the opposite side of the housing, where you have already removed and replaced the fastener with the hole to the opposite side
4. Put the door on the upper hinge fastener.
5. Fix the lower hinge in the new position.
6. Unscrew the handle and place it on the opposite side.
7. Some screws are covered with caps. Take off these caps before undoing the screws.
8. Check the door gasket. It should not be creased and should seal well.

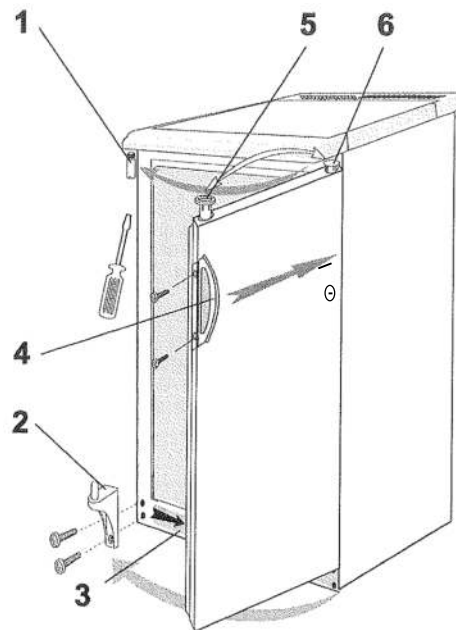

1. Upper hinge fastener
2. Lower hinge
3. Kick plate

4. Handle
5. Door hinge fixture
6. Door hinge fixture plug

*NOTE: The direction of the door swing for “CSS” and “BIIF” models is not reversible by the user.*

## **Adjusting the Tilt**

If your beer cooler seems unsteady or you would like the door to close more easily, you can use the leveling legs to adjust the tilt of the unit.

Be sure that the unit is in its final position when making adjustments to the tilt and that it is plugged into a grounded 3-prong outlet.

### **WARNING:**



*Two or more people are required to move and/or install the refrigerator. Failure to do so may cause back or other injury.*

- Turning a leveling leg to the right will lower the appliance toward the position of the leg. Likewise, turning to the left will raise the unit away from the leg.
- Several turns of the leveling legs may be required before the tilt of the appliance is properly adjusted.
- Turning both front legs the same amount to the left will tilt the kegerator to the rear. This adjustment makes it easier for the door to close.

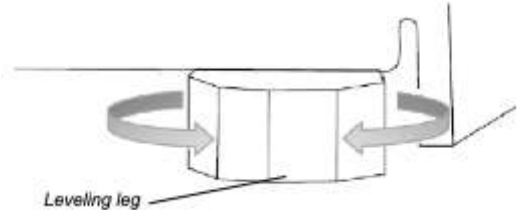

NOTE: It is easier to adjust the leveling legs if someone else pushes against the top of the appliance to take the weight off the legs.

## **Draft Arm Assembly**

1. Slide the gasket over the wing nut on the bottom of draft arm assembly beer tubes. Slide gasket up beer tubes to draft arm base.
2. Push the wing nut on the beer tube of the draft arm assembly through the hole in the top of the cabinet until the draft arm is resting on cabinet top.
3. Align holes in draft arm base with holes in gasket and pilot holes in cabinet, then secure the guard rail to the cabinet top.

## **Beer Kegs and Keg Tappers**

Your kegerator cooler comes with a double tap and will accommodate two “Sixth Barrel” kegs, also known as “sixtels” or “logs”. Each sixtel has a height of 23-3/8” and a diameter of 9-1/4”, and hold 5.16 gallons of beer. Two Cornelius (“Corny”) kegs will also fit. The unit will not hold a half barrel or quarter barrel, although it can take one “Slim Quarter” barrel.

The Sankey type keg tappers supplied with the kegerator are the most widely used in the United States. However, other types of keg tappers can be used. Before installing a keg tapper, check with your beer distributor to make sure that the Sankey type keg tapper can be used.

If you need keg tappers other than the Sankey type, it is recommended that you purchase the tappers you need from your beer distributor. Please keep the Sankey type keg tappers for future use. The Sankey system is becoming more popular. It may be purchased from our Sales Department at **718-893-3900**.

## **CO<sub>2</sub> Regulator and CO<sub>2</sub> Cylinder**

NOTE: Your CO<sub>2</sub> cylinder is shipped empty to avoid any possible accidents during transportation. When you purchase the first keg of beer, have your beer distributor fill the CO<sub>2</sub> cylinder. You must read and understand the following procedures for CO<sub>2</sub> cylinders before installation:

1. Install the CO<sub>2</sub> gas line tube to the regulator by attaching one end of the red tube to the hose connection on the CO<sub>2</sub> regulator.
2. Secure the tube by using one of the self-locking black plastic snap-on clamps.
3. Insert a special washer into the regulator-to-cylinder attachment nut.
4. Attach the CO<sub>2</sub> regulator to the CO<sub>2</sub> cylinder by screwing the regulator nut onto the cylinder valve and tightening with an adjustable wrench.
5. Remove the bolt with the nut from the cylinder retainer. Using two screws, attach it inside the unit on the left side of the back wall. Holes are pre-drilled and screws are included.
6. Slide the cylinder through the retainer and secure it with the bolt and the nut. Position the cylinder this way so that you will be able to read the numbers on the gauges and easily access the shut-off valve.

## **Installation of Accessories**

1. Once the unit has been positioned under the counter, install the beer tower assembly and the mixed ball valve:
  - a. Lower the beer tower through the hole in the counter and into the hole at the top of the beer dispenser's upper surface. Be sure the tap is facing toward the front of the machine.
  - b. Take out the accessories of the mixed ball valve. Attach the transparent hose to the beer outlet of the mixed ball valve. (See Figure 5).

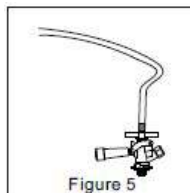

Figure 5

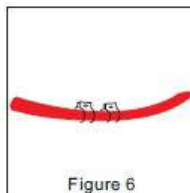

Figure 6

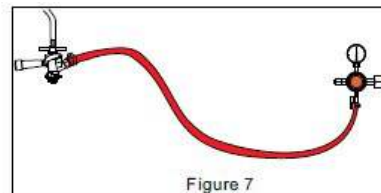

Figure 7

2. Install CO<sub>2</sub> gas cylinder and CO<sub>2</sub> regulator valve:

- a. Fix the two CO<sub>2</sub> hose clamps on the red CO<sub>2</sub> tube (See Figure 6).
- b. Connect the ends of the red CO<sub>2</sub> tube respectively to the CO<sub>2</sub> intake port of the mixed ball valve and the round outlet of the CO<sub>2</sub> regulator valve. Lock these connections firmly with the two clamps on the red CO<sub>2</sub> tube (See Figure 7).
- c. Using the wrench, tighten the CO<sub>2</sub> regulator table valve with the hex nut port to the gas outlet of the CO<sub>2</sub> tank (See Figure 9).



Figure 9

- d. Place the CO<sub>2</sub> tank and CO<sub>2</sub> regulator valve component into the cabinet and fix the CO<sub>2</sub> tank with tank bracket and retainer (See Figure 8).

3. Install the beer keg:

**Note:** This unit can hold two one-sixth barrel kegs, but not a full-size keg.

Place the beer keg into the cabinet and firmly connect the keg's opening to the connection port of the mixed ball valve.

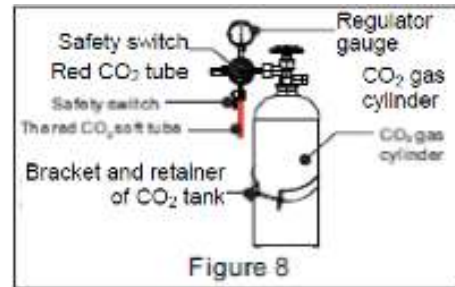

**Note:** To place a keg into the cabinet, use the keg handle to move the keg to the front of the open beer dispenser, then carefully tip the keg so that the raised bottom edge contacts the edge of the cabinet. Finally, lift the keg handle to raise the keg to the level of the floor of the cabinet and push the keg into place.

4. Install tap handle and beer tap:

Screw the tap handle clockwise into the beer tap to make a firm connection. Then connect the tap to the beer tower components and tighten with a wrench (See Figure 9).

**Notes:**

- When replacing the beer keg, first turn off the safety switch on the CO<sub>2</sub> regulator valve and remove the mixed ball valve to take out the keg.
- When replacing the CO<sub>2</sub> gas cylinder, remember to turn off the main switch of the CO<sub>2</sub> gas cylinder and the safety switch on the CO<sub>2</sub> regulator valve. Afterwards, use a wrench to loosen the hexagonal nut port connecting the CO<sub>2</sub> regulator valve with the CO<sub>2</sub> tank. Then, using a wrench, remove the fixed bolt of the CO<sub>2</sub> tank to take out the CO<sub>2</sub> tank.
- During the installation process, be sure that all parts are connected tightly and that there are no gas leaks.
- When connecting the hose to the connection port, you can dip the ends into warm water to make the connection easier.
- If the high-pressure compressed gas in the CO<sub>2</sub> tank is not handled properly, it could be dangerous:
  - Make a note of the D.O.T. testing date on the cylinder neck before installation. If it is more than 5 years old, don't use the product. Return it to the gas supplier.
  - Keep gas cylinder away from heat sources. Unused cylinders should be placed upright in a cool, ventilated place (preferably at 70°F).

**A Note about Freestanding Installation**

If you decide to install your beer cooler in a freestanding position (rather than built-in) you will need to order a special kit, which includes a guard rail and a set of casters. Call our Customer Help Line at **1-800-287-8799** weekdays between 8:30am and 5:00pm ET.

# Operating Your Kegerator

## Temperature Control:

- Your appliance's evaporator system is out of sight behind the interior rear wall.
- The interior temperature is controlled with a thermostat knob located inside the unit, towards the upper right-hand corner. Turn the knob clockwise from the **STOP (0)** position toward the higher numbers for colder temperatures. Higher settings on the knob (higher numbers) mean lower temperatures (colder) in the kegerator.
- On the coldest settings, temperatures in some spots inside the cabinet may drop below 32°F. Use higher thermostat settings only when required or recommended. When the ambient temperature is normal, we recommend a medium setting.
- Changes in the ambient temperature affect the temperature inside the refrigerator so choose an appropriate setting of the thermostat knob, depending on ambient conditions.
- In the **STOP (0)** position, the appliance does not operate (the cooling system is switched off), yet the power supply is not interrupted (the light still works).
- The temperature inside the kegerator also depends on how often you open the door.

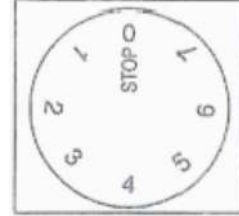

## NOTES: .

1. Interior lighting is controlled by a manually-operated rocker switch. To maintain the proper interior temperature, keep the light on only as long as necessary.
2. If the kegerator is unplugged, has lost power, or is turned off, you must wait 3 to 5 minutes before restarting it. If you attempt to restart before this time delay, the unit will not start.

## Defrosting:

This appliance operates with an automatic defrost system, so it defrosts itself. While the compressor is operating, ice will build along the rear cold wall (the evaporator plate is behind the wall). During the compressor's off-cycle, ice will melt, drip down, collect in the trough at the bottom and drain through a small hole into a tray above the compressor; where the compressor's heat will evaporate the water. If you notice excessive ice build-up on the rear wall, try setting the thermostat to a slightly warmer setting; be sure that the door gasket is sealing well and that there is no obstruction of the drain hole at the bottom rear of the interior cabinet.

## Care and Maintenance

### **Cleaning Your Appliance:**

1. Unplug the appliance, turn the thermostat to **STOP (0)** and remove all contents, including shelves.
2. Wash the inside surfaces with a solution of lukewarm water and vinegar. Wipe dry with a clean, soft cloth.
3. Wash the outside cabinet with a solution of warm water and mild liquid detergent. Rinse well and wipe dry with a clean soft cloth.
4. Wring excess water out of the sponge or cloth before cleaning the area of the temperature control or any electrical parts.
5. From time to time, wipe the condenser on the rear wall with a soft non-metallic brush or vacuum cleaner.
6. After you have cleaned the appliance, reconnect it to the power supply, reset the thermostat and return all contents to their place.

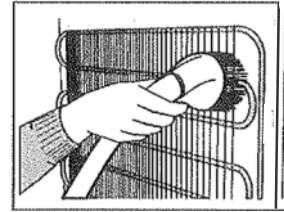

*CAUTION: Failure to unplug the unit could result in electrical shock or personal injury.*

### **Power Failure:**

Most power failures are corrected within a few hours and should not affect the temperature of your appliance if you minimize the number of times the door is opened. If the power is going to be off for a longer period of time, you need to take the proper steps to protect your chilled items.

### **Vacations:**

During long absences, remove all contents. Unplug the appliance, clean it and leave the door open slightly to avoid possible formation of condensation, mold or odors.

### **Moving Your Appliance:**

1. Remove the contents.
2. Securely tape down anything loose inside your unit.
3. Turn the leveling legs up to the base to avoid damage.
4. Tape the door shut.
5. Be sure the appliance stays secure in the upright position during transportation.

### **Energy-Saving Tips:**

- The unit should be located in the coolest area of the room, away from heat-producing appliances or heating ducts and out of direct sunlight.
- Try not to open the door too often, especially when the weather is damp and hot. Once you open the door, close it as soon as possible.
- Occasionally check if the appliance is sufficiently ventilated (adequate air circulation behind the appliance).
- Set the thermostat from higher to lower settings as soon as possible (depending on how loaded the appliance is, ambient temperature, etc.).
- Before loading items into the unit, be sure they have cooled to ambient temperature.

## Draft Beer Troubleshooting

Problem	Cause	Correction	
<p>Beer is cloudy: The beer in the glass appears hazy and not clear.</p>	<p>Excessively low temperatures may cause hazy or cloudy beer, particularly when the beer lies in the cold coil for long periods of time.</p>	Drain a few ounces before drinking.	
		Raise the temperature setting of the unit.	
	<p>Glasses may not have been cleaned properly.</p>	<p>Do not wash beer glasses together with glasses that have contained milk or any other fatty substance. An excessive amount of germicide build-up may also leave a fatty film,</p>	It is preferable to steam and sterilize glasses where health laws permit.
			Wash glasses thoroughly with a good detergent to remove all fatty substances
			Do not use soap.
			Do not wipe the glasses dry. Permit glasses to air-dry by placing them on a wire rack or corrugated metal sheet.
			Rinse the glasses in fresh cold water just before serving beer. It is best to serve beer in a wet glass.
	<p>Improper drawing of beer into glass</p>	<p>Open the faucet quickly and completely; proper foam should be a tight creamy head. The collar on the average glass should be ¾" to 1" high. Beer drawn without a head has the appearance of being flat.</p>	
	<p>Not enough pressure</p>	<p>Increase the pressure if beer runs too slowly. The correct flow should fill a 10-oz glass in 4 seconds (approx. 8 oz of liquid). Check the pressure source to determine whether there are obstructions in the air line. Replace a sluggish air source or the CO<sub>2</sub> regulator and gauge. The tank pressure must always be higher than the pressure used on the keg. Always apply pressure to the keg before drawing beer.</p>	

<p>Beer has off taste: Often bitter and bite-y; sometimes completely lacking flavor and zest. It may also have an oily or foul odor which may carry an unpleasant taste.</p>	<p>Improper cleaning of the tap</p>	<p>Brush and clean the tap properly. It should be scoured using a detergent, then rinsed clean.</p>
	<p>Contaminated air line</p>	<p>Beer tube should be examined. If contaminated, it should be replaced.</p>
<p>Condensation is forming on the tap.</p>	<p>It is normal to see condensation forming on the tap. It is caused by a difference in temperature between the cold beer and the surfaces of the tap when beer is flowing through the line. Beer that is left in the tap is not cooled by the beer dispenser.</p>	<p>After a period of non-use, a few ounces should be drained before drinking.</p>

## General Troubleshooting

When using this appliance, you may come across some problems that in many cases result from improper handling and can easily be eliminated.

### TROUBLESHOOTING GUIDE

*The appliance fails to operate after being connected to the power source.*

- Check whether the power supply is active and that the thermostat is not set to the **STOP (0)** position.

*The compressor is running continuously.*

- The door was opened frequently or it was left open too long.
- The door is not properly closed (the door may sag, the gasket may be dirty or damaged).
- The power supply has been interrupted for a long period of time.
- The appliance may have been overloaded with items above room temperature.
- There may be inadequate ventilation of the compressor and condenser. (Assure there is adequate air circulation behind the appliance and wipe the dust from the condenser.)

*Noise*

- Cooling in refrigeration appliances is enabled by the refrigerating system with a compressor, which produces noise. How noisy the appliance is depends on where it is placed, how it is used and how old the appliance is.
- During the operation of the compressor, the noise of liquid is heard and when the compressor is not operating, the refrigerant flow is heard. This is a normal condition and has no influence whatsoever on the lifetime of the appliance.
- After starting the appliance, the operation of the compressor and the refrigerant flow may be louder. This does not mean that something is wrong. Gradually the noise is reduced.
- Sometimes a louder noise is heard, which is unusual for the appliance. This noise is often a consequence of improper placement of the unit. (The unit should be placed and leveled firmly on a solid base and it should not touch the wall or cabinets standing next to it.)

# Limited Warranty

## ONE-YEAR LIMITED WARRANTY

Within the 48 contiguous United States, for one year from the date of purchase, when this appliance is operated and maintained according to instructions attached to or furnished with the product, warrantor will pay for factory-specified parts and repair labor to correct defects in materials or workmanship. Service must be provided by a designated service company. Outside the 48 states, all parts are warranted for one year from manufacturing defects. Plastic parts, shelves and cabinets are warranted to be manufactured to commercially acceptable standards, and are not covered from damage during handling or breakage.

## 5-YEAR COMPRESSOR WARRANTY

1. The compressor is covered for 5 years.
2. Replacement does not include labor.

### **ITEMS WARRANTOR WILL NOT PAY FOR:**

1. Service calls to correct the installation of your appliance, to instruct you how to use your appliance, to replace or repair fuses or to correct wiring or plumbing.
2. Service calls to repair or replace appliance light bulbs or broken shelves. Consumable parts (such as filters) are excluded from warranty coverage.
3. Damage resulting from accident, alteration, misuse, abuse, fire, flood, acts of God, improper installation, installation not in accordance with electrical or plumbing codes, or use of products not approved by warrantor.
4. Replacement parts or repair labor costs for units operated outside the United States.
5. Repairs to parts or systems resulting from unauthorized modifications made to the appliance.
6. The removal and reinstallation of your appliance if it is installed in an inaccessible location or is not installed in accordance with published installation instructions.

## DISCLAIMER OF IMPLIED WARRANTIES – LIMITATION OF REMEDIES

CUSTOMER'S SOLE AND EXCLUSIVE REMEDY UNDER THIS LIMITED WARRANTY SHALL BE PRODUCT REPAIR AS PROVIDED HEREIN. IMPLIED WARRANTIES, INCLUDING WARRANTIES OF MERCHANTABILITY OR FITNESS FOR A PARTICULAR PURPOSE, ARE LIMITED TO ONE YEAR. WARRANTOR SHALL NOT BE LIABLE FOR INCIDENTAL OR CONSEQUENTIAL DAMAGES. SOME STATES DO NOT ALLOW THE EXCLUSION OR LIMITATION OF INCIDENTAL OR CONSEQUENTIAL DAMAGES, OR LIMITATIONS ON THE DURATION OF IMPLIED WARRANTIES OF MERCHANTABILITY OR FITNESS, SO THESE EXCLUSIONS OR LIMITATIONS MAY NOT APPLY TO YOU. THIS WARRANTY GIVES YOU SPECIFIC LEGAL RIGHTS AND YOU MAY ALSO HAVE OTHER RIGHTS, WHICH VARY FROM STATE TO STATE.

 **WARNING:** This product can expose you to chemicals including Nickel (Metallic) which is known to the State of California to cause cancer.

For more information go to [www.P65Warnings.ca.gov](http://www.P65Warnings.ca.gov)

Note: Nickel is a component in all stainless steel and some other metallic compositions.

**FELIX STORCH, INC.**  
770 Garrison Avenue  
Bronx, NY 10474  
Phone: (718) 893-3900  
Fax: (844) 478-8799  
[www.medicalrefrigerators.com](http://www.medicalrefrigerators.com)



For parts and accessory ordering, troubleshooting and helpful hints, visit:  
[www.summitappliance.com/support](http://www.summitappliance.com/support)

April, 2020  
Printed in the U.S.A.