



# 20" and 24" Compact Gas Ranges

**Safety Instructions** ..... 2-5

**Operating Instructions**

Oven ..... 7-13

Surface Burners ..... 6

**Care and Cleaning**

Broiler Compartment ..... 17

Broiler Pan and Grid ..... 18

Burners ..... 15

Control Panel and Knobs ..... 6

Grates ..... 14

Lift-Up Cooktop ..... 14

Lift-Off Oven Door ..... 18

Oven Interior ..... 19

Painted Surfaces ..... 19

Removable Oven Bottom ..... 17

Shelves ..... 16

Thermostat Adjustment ..... 11

**Installation Instructions** ..... 20-28

LP ..... 28

**Troubleshooting Tips** ..... 29

**Warranty** ..... 31

**Owner's Manual and Installation Instructions**

**Write the model and serial numbers here:**

**Model #** \_\_\_\_\_

**Serial #** \_\_\_\_\_

You can find them on a label under the cooktop. See the Lift-Up Cooktop section in this manual for instructions on how to lift the cooktop.

# IMPORTANT SAFETY INFORMATION.

## READ ALL INSTRUCTIONS BEFORE USING.

**⚠ WARNING** If the information in this manual is not followed exactly, a fire or explosion may result, causing property damage, personal injury or death.

- Do not store or use gasoline or other flammable vapors and liquids in the vicinity of this or any other appliance.

**- WHAT TO DO IF YOU SMELL GAS**

- Do not try to light any appliance.
  - Do not touch any electrical switch; do not use any phone in your building.
  - Immediately call your gas supplier from a neighbor's phone. Follow the gas supplier's instructions.
  - If you cannot reach your gas supplier, call the fire department.
- Installation and service must be performed by a qualified installer, service agency or the gas supplier.

**⚠ WARNING** All ranges can tip. BURNS or other SERIOUS INJURIES can result. INSTALL and CHECK the anti-tip bracket following the instructions supplied with the bracket. To reduce the risk of tipping the range, the range must be secured by a properly installed anti-tip bracket. See installation instructions shipped with the bracket for complete details before attempting to install.



To check if the bracket is installed and engaged properly, look underneath the range to see that the rear leveling leg is engaged in the bracket. On some models, the storage drawer or kick panel can be removed for easy inspection. If visual inspection is not possible, slide the range forward, confirm the anti-tip bracket is securely attached to the floor or wall, and slide the range back so the rear leveling leg is under the anti-tip bracket.

If the range is pulled from the wall for any reason, always repeat this procedure to verify the range is properly secured by the anti-tip bracket.

Never completely remove the leveling legs or the range will not be secured to the anti-tip device properly.

If you did not receive an anti-tip bracket with your purchase, call 1-800-932-4267 toll-free to receive one at no cost.

Never completely remove the leveling legs or the range will not be secured to the anti-tip device properly.

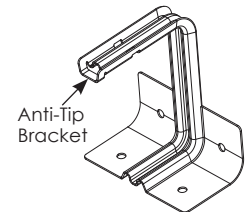

Free-Standing Ranges

## **⚠ WARNING** IMPORTANT SAFETY NOTICE

The California Safe Drinking Water and Toxic Enforcement Act requires the Governor of California to publish a list of substances known to the state to cause cancer, birth defects or other reproductive harm, and requires businesses to warn customers of potential exposure to such substances.

The fiberglass insulation in self-clean ovens gives off a very small amount of carbon monoxide during the cleaning cycle. Exposure can be minimized by venting with an open window or using a ventilation fan or hood.

SAVE THESE INSTRUCTIONS

## **⚠ WARNING**

## GENERAL SAFETY INSTRUCTIONS

### **⚠ WARNING**

**NEVER use this appliance as a space heater to heat or warm the room. Doing so may result in carbon monoxide poisoning and overheating of the oven.**

- Use this appliance for its intended purpose as described in this owners manual.
- Have your range installed and properly grounded by a qualified installer in accordance with the provided installation instructions. Any adjustment and service should be performed only by qualified gas range installers or service technicians. Do not attempt to repair or replace any part of your range unless it is specifically recommended in this manual.
- Your range is shipped from the factory set for use with natural gas. It can be converted for use with LP gas. If required, these adjustments must be made by a qualified technician in accordance with the installation instructions and local codes. The agency performing this work assumes responsibility for the conversion.
- Have the installer show you the location of the range gas shut-off valve and how to turn it off if necessary.
- Plug your range into a 120-volt grounded outlet only. Do not remove the round grounding prong from the plug. If in doubt about the grounding of the home electrical system, it is your responsibility and obligation to have an ungrounded outlet replaced with a properly grounded, three prong outlet in accordance with the National Electrical Code. Do not use an extension cord with this appliance.
- Before performing any service, unplug the range or disconnect the power supply at the household distribution panel by removing the fuse or switching off the circuit breaker.
- Be sure all packing materials are removed from the range before operating to prevent ignition of these materials.
- Avoid scratching or impacting glass doors, cooktops or control panels. Doing so may lead to glass breakage. Do not cook on a product with broken glass. Shock, fire or cuts may occur.
- Do not leave children alone or unattended in an area where an appliance is in use. They should never be allowed to climb, sit or stand on any part of the appliance.
- Do not store items of interest to children above a range or on the backguard of a range—children climbing on the range to reach items could be seriously injured.
- Do not allow anyone to climb, stand or hang on the oven door, drawer or cooktop. They could damage the range or tip it over causing severe injury or death.
- Never block the vents (air openings) of the range. They provide the air inlets and outlets that are necessary for the range to operate properly with correct combustion. Air openings are located at the rear of the cooktop, at the top and bottom of the oven door, and at the bottom of the range under the warming drawer, lower oven drawer or kick panel.
- Use only dry pot holders—moist or damp pot holders on hot surfaces may result in burns from steam. Do not let pot holders touch surface burners, burner grate, or oven heating element Do not use a towel or other bulky cloth in place of pot holders.
- Be careful not to touch hot surfaces of the range. Potentially hot surfaces include burners, grates, cooktop, backguard, oven and door interior and crevices around the oven door.
- Do not heat unopened food containers. Pressure could build up and the container could burst, causing an injury.
- To protect against foodborne illness, ensure that temperatures of meat and poultry products meet or exceed the USDA minimum recommended temperatures for food safety. For more information see: **[www.isitdoneyet.gov](http://www.isitdoneyet.gov)** or call the USDA meat and poultry hotline at **1-888-674-6854**.

SAVE THESE INSTRUCTIONS

# IMPORTANT SAFETY INFORMATION.

## READ ALL INSTRUCTIONS BEFORE USING.

---

### **⚠ WARNING** KEEP FLAMMABLE MATERIALS AWAY FROM THE RANGE

---

- Do not store or use flammable materials in an oven or near the cooktop, including paper, plastic, pot holders, linens, wall coverings, curtains, drapes and gasoline or other flammable vapors and liquids.
- Never wear loose-fitting or hanging garments while using the appliance. Avoid storing commonly used items in cabinets above the range and be careful when reaching over the range. Clothing in close proximity to burners or hot surfaces may ignite causing severe burns.
- Do not let cooking grease or other flammable materials accumulate in or near the range. Grease in the oven or on the cooktop may ignite.
- Clean ventilating hoods frequently. Grease should not be allowed to accumulate on the hood or filter.

### **⚠ WARNING** IN THE EVENT OF A FIRE, TAKE THE FOLLOWING STEPS TO PREVENT INJURY AND FIRE SPREADING:

---

- Do not use water on grease fires. Never pick up a flaming pan. Turn the controls off. Smother a flaming pan on a surface burner by covering the pan completely with a well-fitting lid, cookie sheet or flat tray. If necessary, use a multipurpose dry chemical or foam-type fire extinguisher.
- If there is a fire in the oven during baking, turn the oven off and keep the door closed until the fire goes out. If necessary, use a multipurpose dry chemical or foam type fire extinguisher.
- If there is a fire in the oven during self-clean, turn the oven off and wait for the fire to go out. Do not force the door open. Introduction of fresh air at self-clean temperatures may lead to a burst of flame from the oven. Failure to follow this instruction may result in severe burns.

### **⚠ WARNING** COOKTOP SAFETY INSTRUCTIONS

---

- Never leave the surface burners unattended at medium or high heat settings. Foods, especially oily foods, may ignite resulting in fire that could spread to surrounding cabinets.
- Never leave oil unattended while frying. If allowed to heat beyond its smoking point, oil may ignite resulting in fire that may spread to surrounding cabinets. Use a deep fat thermometer whenever possible to monitor oil temperature.
- To avoid oil spillover and fire, use a minimum amount of oil when shallow pan-frying and avoid cooking frozen foods with excessive amounts of ice.
- Use proper pan size and avoid pans that are unstable or easily tipped. Select cookware that is matched to the size of the burner. Burner flames should be adjusted so that they do not extend beyond the bottom of the pan. Excessive flame may be hazardous.
- Always use the LITE position when igniting the top burners and make sure the burners have ignited.
- When using glass/ceramic cookware, make sure it is suitable for cooktop service; others may break because of sudden change in temperature.
- To minimize the possibility of burns, ignition of flammable materials and spillage, the handle of a container should be turned toward the center of the range without extending over nearby burners.
- When preparing flaming foods under a hood, turn the fan on.
- Do not use a wok with a round metal support ring, the ring may trap heat and block air to the burner resulting in a carbon monoxide hazard.
- Do not attempt to lift the cooktop if your range has sealed surface burners. Doing so may damage the gas tubing to the surface burners resulting in a gas leak and risk of fire.
- Do not use aluminum foil to cover the grates or line any part of the cooktop. Doing so may result in carbon monoxide poisoning, overheating of the cooktop surfaces, or a potential fire hazard.

SAVE THESE INSTRUCTIONS

---

## **⚠ WARNING** OVEN SAFETY INSTRUCTIONS

---

**⚠ WARNING** NEVER cover any slots, holes, or passages in the oven bottom or cover an entire rack with materials such as aluminum foil. Doing so blocks airflow through the oven and may cause carbon monoxide poisoning. Aluminum foil linings may also trap heat, causing a fire hazard.

- Stand away from the range when opening the oven door. Hot air or steam which escapes can cause burns to hands, face and/or eyes.
- Keep the oven free from grease buildup. Grease in the oven may ignite.
- Place oven racks in desired location while oven is cool. If rack must be moved while oven is hot, be careful to avoid touching hot surfaces.
- Pull the oven rack to the stop-lock position when loading and unloading food from the oven. This helps prevent burns from touching hot surfaces of the door and oven walls.
- Do not leave items such as paper, cooking utensils or food in the oven when not in use. Items stored in an oven can ignite.
- Do not leave items on the cooktop near the oven vent which is in the center of the backguard. Items may overheat resulting in a risk of fire or burns.
- When using cooking or roasting bags in the oven, follow the manufacturer's directions.
- Never broil with door open. Open-door broiling is not permitted due to overheating of control knobs.

---

## **⚠ WARNING** WARMING DRAWER/LOWER OVEN DRAWER SAFETY INSTRUCTIONS (*Some models*)

---

- The purpose of the warming drawer is to hold hot cooked foods at serving temperature. Bacteria will grow very rapidly in food that is between 40 and 140°F. Do not put cold food in warming drawer. Do not keep food in the warming drawer for more than 2 hours. Failure to follow these instructions may result in foodborne illness.
- Do not leave paper products, plastics, canned food or combustible materials in the drawer. They may ignite.
- Do not touch the heating element or the interior surface of the drawer. These surfaces may be hot enough to cause burns.
- Use care when opening the drawer. Open the drawer a crack and let hot air or steam escape before removing or replacing food. Hot air or steam that escapes can cause burns to hands, face and/or eyes.
- Do not use aluminum foil to line the warming drawer. Foil is an excellent heat insulator and will trap heat beneath it. This will upset the performance of the drawer and potentially cause a fire hazard.

**⚠ WARNING** Read all safety instructions before using the product. Failure to follow these instructions may result in fire, electric shock, serious injury or death.

SAVE THESE INSTRUCTIONS

# Using the gas surface burners.

Throughout this manual, features and appearance may vary from your model.

## Before Lighting a Gas Burner

- Make sure all burners are in place.
- Make sure all grates on the range are properly placed before using any burner.

## After Lighting a Gas Burner

- Do not operate the burner for an extended period of time without cookware on the grate. The finish on the grate may chip without cookware to absorb the heat.

Be sure the burners and grates are cool before you place your hand, a pot holder, cleaning cloths or other materials on them.

## How to Light a Gas Surface Burner

Make sure all the surface burners are placed in their respective positions. Push the control knob in and turn it to the **LITE** position.

You will hear a little **clicking** noise—the sound of the electric spark igniting the burner.

Turn the knob to adjust the flame size. If the knob stays at LITE, it will continue to click.

When one burner is turned to LITE, all the burners spark. Do not attempt to disassemble or clean around any burner while another burner is on. An electric shock may result, which could cause you to knock over hot cookware.

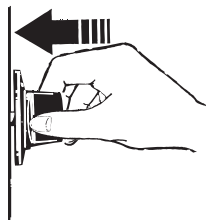

Push the control knob in and turn it to the LITE position.

## How to Select Flame Size

### **⚠ WARNING**

**Flames that are not covered by cookware may present a risk of burns or clothing ignition. Never let flames extend beyond the sides of the cookware.**

Watch the flame, not the knob, as you adjust heat. When fast heating is desired, the flame size on a gas burner should match the cookware you are using.

Flames larger than the bottom of the cookware will not result in faster heating and may be hazardous.



## Top-of-Range Cookware

**Aluminum:** Medium-weight cookware is recommended because it heats quickly and evenly. Most foods brown evenly in an aluminum skillet. Use saucepans with tight fitting lids when cooking with minimum amounts of water.

**Cast-Iron:** If heated slowly, most skillets will give satisfactory results.

**Enamelware:** Under some conditions, the enamel of some cookware may melt. Follow cookware manufacturer's recommendations for cooking methods.

**Glass:** There are two types of glass cookware—those for oven use only and

those for top-of-range cooking (saucepans, coffee and teapots). Glass conducts heat very slowly.

**Heatproof Glass Ceramic:** Can be used for either surface or oven cooking. It conducts heat very slowly and cools very slowly. Check cookware manufacturer's directions to be sure it can be used on gas ranges.

**Stainless Steel:** This metal alone has poor heating properties and is usually combined with copper, aluminum or other metals for improved heat distribution. Combination metal skillets usually work satisfactorily if they are used with medium heat as the manufacturer recommends.

## In Case of Power Failure

In case of a power failure, you can light the gas surface burners on your range with a match. Hold a lit match to the burner, then push in and turn the control knob to the LITE position. Use extreme caution when lighting burners this way.

Surface burners in use when an electrical power failure occurs will continue to operate normally.

# Using the oven.

Throughout this manual, features and appearance may vary from your model.



## Oven Control

Your oven is controlled by an OVEN TEMP knob. It can take up to 90 seconds before the flame comes on.

After the oven reaches the selected temperature, the oven burner maintains the selected temperature.

## Power Outage

The oven or broiler cannot be lit during a power failure.

If the oven is in use when a power failure occurs, the oven burner shuts off. This is because the flow of gas is automatically stopped and will not resume until power is restored.

To avoid possible burns, place the shelves in the desired position before you turn the oven on.

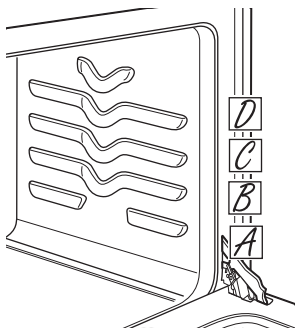

The oven has 4 shelf positions.

## Before you begin...

The shelves have stop-locks, so that when placed correctly on the shelf supports (A through D), they will stop before coming completely out, and will not tilt.

When placing and removing cookware, pull the shelf out to the bump on the shelf support.

## CAUTION

**CAUTION** When you are using a rack in the lowest position (A), you will need to use caution when pulling the rack out. We recommend that you pull the rack out several inches and then, using two pot holders, pull the rack out by holding the sides of it. The rack is low and you can be burned if you put your hand in the middle of the rack and pull all the way out.

**To remove a shelf,** pull it toward you, tilt the front end up and pull it out.

**To replace,** place the end of the shelf (stop-locks) on the support, tilt up the front and push the shelf in.

**NOTE:** The shelf is not designed to slide out at the special low shelf (A) position.

## Using the oven.

---

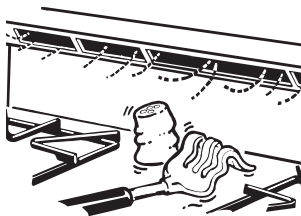

Plastic items on the cooktop may melt if left too close to the vent. Vent appearance and location vary.

### Upper Oven Vent

Your oven is vented through ducts at the rear of the range. Do not block these ducts when cooking in the oven—it is important that the flow of hot air from the oven and fresh air to the oven burner be uninterrupted. Avoid touching the vent openings or nearby surfaces during oven or broiler operation—they may become hot.

- Handles of pots and pans on the cooktop may become hot if left too close to the vent.

- Do not leave plastic or flammable items on the cooktop—they may melt or ignite if left too close to the vent.
- Do not leave closed containers on the cooktop. The pressure in closed containers may increase, which may cause them to burst.
- Metal items will become very hot if they are left on the cooktop, and could cause burns.

---

### Oven Light

Use the switch on the lower control panel to turn the light on or off.

---

## The type of margarine will affect baking performance!

---

*Most recipes for baking have been developed using high-fat products such as butter or margarine (80% fat). If you decrease the fat, the recipe may not give the same results as with a higher-fat product.*

*Recipe failure can result if cakes, pies, pastries, cookies or candies are made with low-fat spreads. The lower the fat content of a spread product, the more noticeable these differences become.*

*Federal standards require products labeled "margarine" to contain at least 80% fat by weight. Low-fat spreads, on the other hand, contain less fat and more water. The high moisture content of these spreads affects the texture and flavor of baked goods. For best results with your old favorite recipes, use margarine, butter or stick spreads containing at least 70% vegetable oil.*

# Using the oven for baking.

To avoid possible burns, place the shelves in the desired position before you turn the oven on.

## How to Set the Oven For Baking

1. Close the oven door. Then turn the **OVEN TEMP** knob to the desired temperature.
2. Check the food for doneness at the minimum time on the recipe. Cook longer if necessary. Turn the **OVEN TEMP** knob to **OFF** and remove the food.

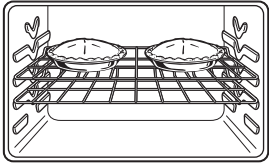

Place most foods in the middle of the oven.

## Oven Shelves

Arrange the oven shelf or shelves in the desired locations while the oven is cool. The correct shelf position depends on the kind of food and the browning desired.

As a general rule, place most foods in the middle of the oven, on either the shelf position B or C. See the chart for suggested shelf positions.

| Type of Food                  | Shelf Position |
|-------------------------------|----------------|
| Angel food cake               | A              |
| Biscuits, muffins or cupcakes | B or C         |
| Cookies                       | C or D         |
| Brownies                      | B or C         |
| Layer cakes                   | B or C         |
| Bundt or pound cakes          | B              |
| Pies or pie shells            | B or C         |
| Frozen pies (on cookie sheet) | B or C         |
| Casseroles                    | B or C         |

To preheat, set the oven at the correct temperature—selecting a higher temperature does not shorten the preheat time.

## Preheating

Preheat the oven for 10 minutes if the recipe calls for it. Preheat means bringing the oven up to the specified temperature before putting the food in the oven.

Preheating is necessary for good results when baking cakes, cookies, pastry and breads. For most casseroles and roasts, preheating is not necessary.

## Baking Pans

Use the proper baking pan. The type of finish on the pan determines the amount of browning that will occur.

- Glass baking dishes also absorb heat. When baking in glass baking dishes, lower the temperature by 25°F and use the recommended cooking time in the recipe. This is not necessary when baking pies or casseroles.

- Dark, rough or dull pans absorb heat resulting in a browner, crisper crust. Use this type for pies.
- Shiny, bright and smooth pans reflect heat, resulting in a lighter, more delicate browning. Cakes and cookies require this type of pan.

## Pan Placement

For even cooking and proper browning, there must be enough room for air circulation in the oven. Baking results will be better if baking pans are centered as much as possible rather than being placed to the front or to the back of the oven.

Pans should not touch each other or the walls of the oven. Allow 1 to 1 1/2 inch space between pans as well as from the back of the oven, the door and the sides.

*If you need to use two shelves, stagger the pans so one is not directly above the other.*

# Using the oven for baking.

---

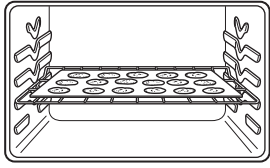

For best results, use only one cookie sheet in the oven at a time.

## Cookies

Flat cookie sheets (without sides) produce better-looking cookies. Cookies baked in a jelly roll pan (short sides all around) may have darker edges and pale or light browning may occur.

Do not use a cookie sheet so large that it touches the walls or the door of the oven. Never entirely cover a shelf with a large cookie sheet.

---

## Pies

For best results, bake pies in dark, rough or dull pans to produce a browner, crisper crust.

*Frozen pies in foil pans should be placed on an aluminum cookie sheet for baking since the shiny foil pan reflects heat away from the pie crust; the cookie sheet helps retain it.*

---

## Cakes

*When baking cakes, warped or bent pans will cause uneven baking results and poorly shaped products.*

A cake baked in a pan larger than the recipe recommends will usually be crisper, thinner and drier than it should be.

If baked in a pan smaller than recommended, it may be undercooked and batter may overflow.

*Check the recipe to make sure the pan size used is the one recommended.*

---

## Don't Peek

Set the timer for the estimated cooking time and do not open the door to look at your food. Most recipes provide minimum and maximum baking times such as "bake 30-40 minutes."

*DO NOT open the door to check until the minimum time. Opening the oven door frequently during cooking allows heat to escape and makes baking times longer. Your baking results may also be affected.*

---

## Aluminum Foil

Do not use aluminum foil to line oven bottoms. The foil will trap heat below and upset the performance of the oven. Foil can melt and permanently damage the oven bottom. Damage from improper use of aluminum foil is not covered by the product warranty.

Foil may be used to catch spills by placing a sheet on a lower rack, several inches below the food. Do not use more foil than necessary and never entirely cover an oven rack with aluminum foil. Keep foil at least 1-1/2" from oven walls to prevent poor heat circulation.

---

## Oven Moisture

As your oven heats up, the temperature change of the air in the oven may cause water droplets to form on the door glass. These droplets are harmless and will evaporate as the oven continues to heat up.

## Using the oven for roasting.

Roasting is cooking by dry heat. Tender meat or poultry can be roasted uncovered in your oven. Roasting temperatures, which should be low and steady, keep spattering to a minimum.

Roasting is really a baking procedure used for meats. Roasting is easy just follow these directions:

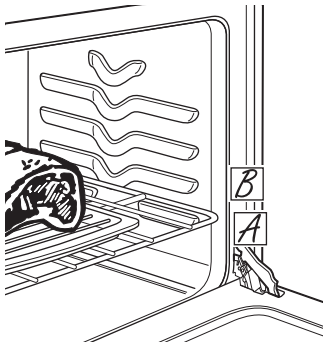

Place the shelf in the A or B position.

### How to Set the Oven For Roasting

1. Place the shelf in the **A** or **B** position. No preheating is necessary.
2. Check the weight of the meat. Place it fat side up (or for poultry, breast-side-up) on a roasting rack in a shallow pan. The melting fat will baste the meat. Select a pan as close to the size of the meat as possible. Line the pan with aluminum foil when using the pan for marinating, cooking with fruits, cooking heavily cured meats or basting food during cooking.
3. Turn the **OVEN TEMP** knob to the desired setting.
4. After roasting is complete, turn the **OVEN TEMP** knob to **OFF** and then remove the food from the oven.

## Adjust the oven thermostat—Easy to do yourself!

You may find that your new oven cooks differently than the one it replaced. Use your new oven for a few weeks to become more familiar with it. If you still think your new oven is too hot or too cold, you can adjust the thermostat yourself.

Do not use thermometers, such as those found in grocery stores, to check the temperature setting of your oven. These thermometers may vary 20-40°F.

**NOTE:** This adjustment will not affect the broiling temperatures. The adjustment will be retained in memory after a power failure.

### To Adjust the Thermostat with this Type of Knob

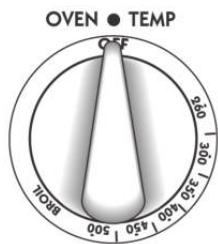

Front of OVEN TEMP knob (knob appearance may vary)

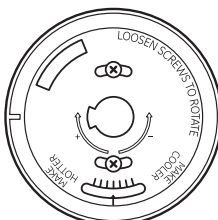

Back of OVEN TEMP knob

1. **Pull the OVEN TEMP knob off the range and look at the back side.**  
To make an adjustment, loosen (approximately one turn), but do not completely remove, the two screws on the back of the knob.
2. With the back of the knob facing you, hold the outer edge of the knob with one hand and turn the front of the knob with the other hand.

**To increase** the oven temperature, move the top screw toward the right. You'll hear a click for each notch you move the knob.

**To decrease** the oven temperature, move the top screw toward the left.

- Each click will change the oven temperature approximately 10°F. (Range is plus or minus 60°F from the arrow.) We suggest that you make the adjustment one click from the original setting and check oven performance before making any additional adjustments.
3. After the adjustment is made, retighten screws so they are snug, but be careful not to overtighten.
  4. Replace the knob, matching the flat area of the knob to the shaft, and check performance.

## Using the oven for broiling (some models).

---

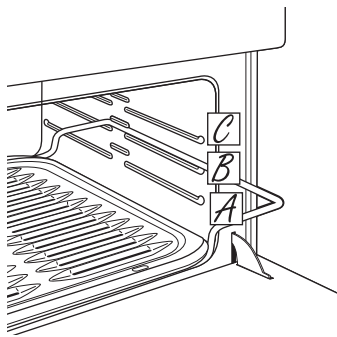

### How to Set the Broiler Compartment

Broiling is cooking food by direct heat from above the food. Most fish and tender cuts of meat can be broiled. Follow these directions to keep spattering and smoking to a minimum.

Your range has a compartment below the oven for broiling.

**Both the oven and broiler compartment doors must be closed during broiling.**

Turn most foods once during cooking (the exception is thin fillets of fish; oil one side, place that side down on broiler grid and cook without turning until done). Time foods for about one-half the total cooking time, turn food, then continue to cook to preferred doneness.

1. You can change the distance of the food from the heat source by positioning the broiler pan and grid on one of three rack positions in the broiler compartment—A (bottom of broiler compartment), B (middle) and C (top).
2. Preheating the broiler or oven is not necessary and can produce poor results.

3. If meat has fat or gristle around the edge, cut vertical slashes through both about 2" apart. If desired, the fat may be trimmed, leaving a layer about 1/8" thick.
4. Arrange the food on the grid and position the broiler pan on the appropriate rack in the oven or broiling compartment. Placing food closer to the flame increases exterior browning of the food, but also increases spattering and the possibility of fats and meat juices igniting.
5. Close the oven and broiler compartment door.
6. Turn the **OVEN CONTROL** knob to **BROIL**.
7. When broiling is finished, turn the **OVEN CONTROL** knob to **OFF**. Remove the broiler pan from the broiler compartment and serve the food immediately. Leave the pan outside the range to cool.

## Using the oven for broiling.

---

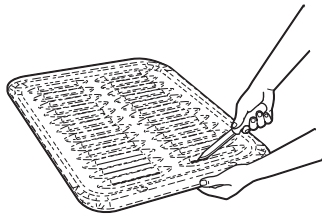

### Aluminum Foil

You can use aluminum foil to line your broiler pan and broiler grid. However, you must mold the foil tightly to the grid and cut slits in it just like the grid.

---

### Broiling Compartment Guide Suggestions

Both the oven and broiler compartment doors must be closed during broiling.

- Always use the broiler pan and grid that comes with your range. It is designed to minimize smoking and spattering by trapping juices in the shielded lower part of the pan.
- For steaks and chops, slash fat evenly around the outside edges of the meat. To slash, cut crosswise through the outer fat surface just to the edge of the meat. Use tongs to turn the meat over to prevent piercing the meat and losing juices.
- If desired, marinate meats or chicken before broiling. Or brush with barbecue sauce last 5-10 minutes only.
- When arranging the food on the pan, do not let fatty edges hang over the sides because dripping fat could soil the oven.
- The broiler compartment does not need to be preheated. However, for very thin foods, or to increase browning, preheat if desired.
- Frozen steaks can be broiled by positioning the rack at the next lowest rack position and increasing the cooking time given in this guide 1 1/2 times per side.

USDA recommends the following minimum safe internal temperatures:

- Raw beef, pork, lamb, and veal steaks or chops: 145°F as measured with a food thermometer before removing meat from the heat source. For safety and quality, allow meat to rest for at least three minutes before carving or consuming.
- Raw ground beef, pork, lamb or veal: 160°F as measured with a food thermometer.
- Poultry: 165°F as measured with a food thermometer

For more information see: [www.isitdoneyet.gov](http://www.isitdoneyet.gov) or call the USDA meat and poultry hotline at **1-888-674-6854**.

# Care and cleaning of the range.

Be sure electrical power is off and all surfaces are cool before cleaning any part of the range.

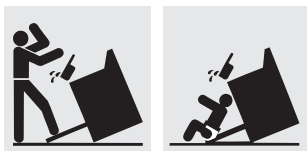

## **⚠ WARNING**

If your range is removed for cleaning, servicing or any reason, be sure the anti-tip device is reengaged properly when the range is replaced. Failure to take this precaution could result in tipping of the range and cause injury.

To check if the bracket is installed and engaged properly, carefully tip the range forward. The bracket should stop the range within 4 inches. If it does not, the bracket must be reinstalled.

If the range is pulled from the wall for any reason, always repeat this procedure to verify the range is properly secured by the anti-tip bracket.

If your range has no anti-tip bracket, call 1.800.932.4267 to receive one at no cost.

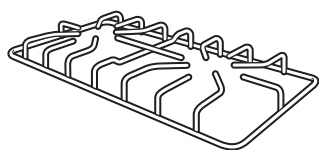

## **Burner Grates**

Your range has two or three professional-style double grates. These grates are position specific. For maximum stability, these grates should only be used in their proper position; they cannot be interchanged left to right or front to back. For convenience, the undersides of the left and right grates are marked "LEFT FRONT" and "RIGHT FRONT."

Make sure the front portion of both grates is in front. The middle grate has a bow in front. Make sure the bowed portion is toward the front of the range. In addition, the middle grate is supported by the left and right grates and must be installed LAST for stability.

### **Cleaning**

Lift out when cool. Grates should be washed regularly and, of course, after spillovers. Wash them in hot, soapy water and rinse with clean water. When replacing the grates, be sure they are positioned securely over the burners.

Replace the grates so that continuous arcs are formed with the center ribs of all three grates.

Do not operate a burner for an extended period of time without cookware on the grate. The finish on the grate may chip without cookware to absorb the heat.

To get rid of burned-on food, place the grates in a covered container. Add 1/4 cup ammonia and let them soak several hours or overnight. Wash, rinse well and dry.

Although they are durable, the grates will gradually lose their shine, regardless of the best care you can give them. This is due to their continual exposure to high temperatures. You will notice this sooner with lighter color grates.

**NOTE:** Do not clean the grates in a self-cleaning oven.

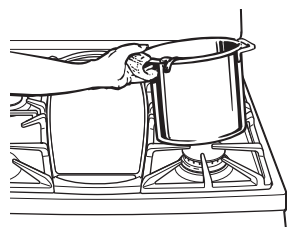

## **Cooktop Surface**

To avoid damaging the porcelain-enamel surface of the cooktop and to prevent it from becoming dull, clean up spills right away. Foods with a lot of acid (tomatoes, sauerkraut, fruit juices, etc.) or foods with high sugar content could cause a dull spot if allowed to set.

When the surface has cooled, wash and rinse. For other spills such as fat splatterings, wash with soap and water once the surface has cooled. Then rinse and polish with a dry cloth.

**NOTE:** For stainless steel cooktops, refer to the Stainless steel surfaces section.

# Care and cleaning of the range.

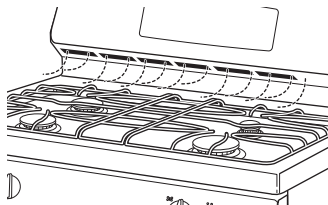

## Oven Air Vents

Never block the vents (air openings) of the range. They provide the air inlet and outlet that are necessary for the range to operate properly with correct combustion.

Air openings are located at the rear of the cooktop, at the top and bottom of the oven door, and at the bottom of the range.

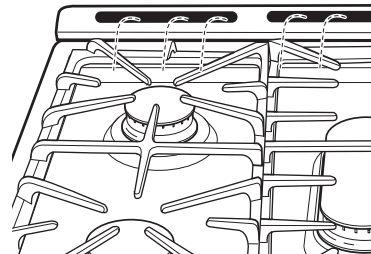

Vent appearance and location vary.

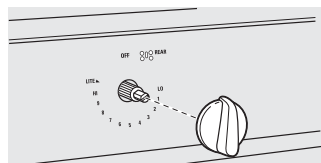

Surface burner knob

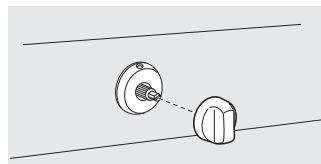
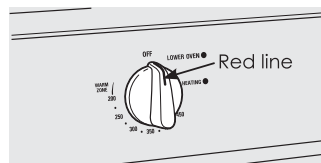

Lower oven knob (on some models)

## Lower Control Panel (Front Manifold Panel) and Knobs

It's a good idea to wipe the control panel after each use of the oven. Use a damp cloth to clean or rinse. For cleaning, use mild soap and water or a 50/50 solution of vinegar and water. For rinsing, use clean water. Polish dry with a soft cloth.

Do not use abrasive cleansers, strong liquid cleaners, plastic scouring pads or oven cleaners on the control panel—they will damage the finish.

Do not try to bend knobs by pulling them up or down or by hanging a towel or other such loads. This can damage the gas valve shaft.

The control knobs may be removed for easier cleaning.

Make sure the knobs are in the **OFF** positions and pull them straight off the stems for cleaning.

The knobs can be cleaned in a dishwasher or they may also be washed with soap and water. Make sure the insides of the knobs are dry before replacing.

Replace the knobs in the **OFF** position to ensure proper placement.

Metal parts can be cleaned with soap and water. Do not use steel wool, abrasives, ammonia, acids or commercial oven cleaners. Dry with a soft cloth.

**NOTE:** Knobs are not interchangeable. Be sure to reinstall the knobs to the original location.

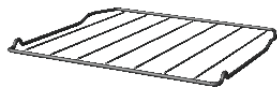

## Oven Shelves and Broiler Rack

The shelves and broiler rack can be cleaned by hand using soap and water or with an abrasive cleaner or steel wool. After cleaning, rinse the shelves and broiler rack with clean water and dry with a clean cloth.

After cleaning, grease all oven rack edges with a light coating of vegetable oil. This will help maintain the ease of sliding the racks in and out of the oven.

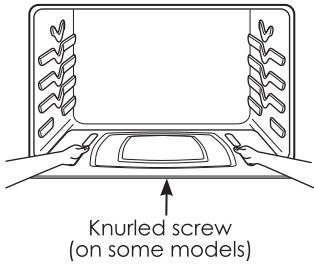

### Removable Oven Bottom

First remove the shelves from the oven. The oven bottom lifts from the front.

#### To remove:

1. On models so equipped, remove the knurled screw in the front of the oven bottom.
2. Grasp each side of the oven bottom and push it back.
3. Lift the front up and pull it out of the oven.

#### To replace:

1. Grasp each side of the oven bottom and guide its rear tabs into the slots in the back of the oven.
2. Lower the oven bottom and pull it forward until it is secure under the front oven floor edge.
3. On models so equipped, replace the knurled screw in the front of the oven bottom.

**NOTE:** If the oven bottom is replaced incorrectly, it may warp and cause undesirable baking results.

### Oven Bottom

The oven bottom has a porcelain-enamel finish. To make cleaning easier, protect the oven bottom from excessive spills by placing a cookie sheet on the rack below the rack you are cooking on. This is particularly important when baking a fruit pie or other foods with a high acid content. Hot fruit fillings or other foods that are highly acidic (such as tomatoes, sauerkraut and

sausages with vinegar or lemon juice) may cause pitting and damage to the porcelain-enamel surface and should be wiped up immediately.

To clean up spills, use soap and water, an abrasive cleaner or soap-filled scouring pad. Rinse well to remove any soap before selfcleaning.

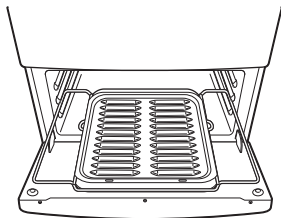

### Broiler Compartment

The broiler pan is held in place in the broiler rack.

#### To remove the broiler pan:

1. Gently pull forward on the drop down broiler door.
2. Pull the broiler rack with pan forward until the rack stops. Grasp the broiler pan and remove it from the broiler rack.

#### To replace the broiler pan:

1. Slide the broiler pan onto the rack and push both the broiler pan and the rack all the way into the broiler compartment.
2. Close the broiler door.

If a spillover occurs in the broiler compartment, allow the compartment to cool first. You can clean the compartment with soap and water, a mild abrasive cleanser, soap-filled scouring pads or an oven cleaner following package directions.

# Care and cleaning of the range.

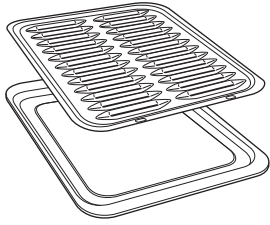

## Broiler Pan and Grid

After broiling, remove the broiler pan from the oven. Remove the grid from the pan. Carefully pour out grease from the pan into a proper container. Wash and rinse the broiler pan and grid in hot water with a soap-filled or plastic scouring pad.

If food has burned on, sprinkle the grid with detergent while hot and cover with wet paper towels or a dishcloth. Soaking the pan will remove burned on foods.

Do not store a soiled broiler pan and grid anywhere in the range.

## Lift-Off Oven Door

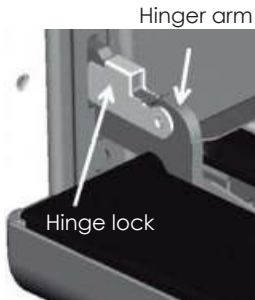

The oven door is removable, but it is heavy. You may need help removing and replacing the door.

### To remove the door:

1. Open the door to the full open position.
2. Pull the hinge locks up over the hinge hooks on both sides. You may need to use a flat-blade screwdriver to lift hinge locks up.
3. Grasp the door firmly on each side, lift slightly and pull it straight out and away from the oven.

### To replace the door:

1. Firmly grasp both sides of the door at the top.
2. Insert and seat the upper and lower hinge arms into the oven slots.
3. Push the hinge locks down from the hinge hooks.
4. Close the oven door and make sure it is working properly. If it is not working properly, remove and replace it following the above steps.

**DO NOT ATTEMPT TO CLOSE THE DOOR UNTIL THIS STEP IS COMPLETE. THE HINGE OR DOOR COULD BE DAMAGED.**

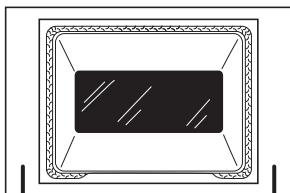
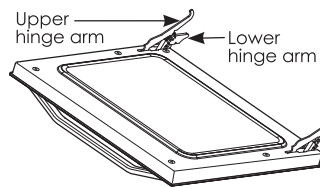

The gasket is designed with a gap at the bottom to allow for proper air circulation.

Do not rub or clean the door gasket—it has an extremely low resistance to abrasion.

If you notice the gasket becoming worn, frayed or damaged in any way or if it has become displaced on the door, you should have it replaced.

### TO CLEAN THE DOOR:

#### To clean the inside of the door:

- Do not allow excess water to run into any holes or slots in the door.
- Wipe dishwashing detergent over any baked-on spatters on the glass. Use a single sided safety razor blade to clean it off. Then wipe over the glass with a soapy cloth to remove any residue and dry off.
- The area outside the gasket can be cleaned with a soap-filled plastic scouring pad.

#### To clean the outside of the door:

- Use soap and water to thoroughly clean the top, sides and front of the oven door. Rinse well. You may also use a glass cleaner to clean the glass on the outside of the door.
- Spillage of marinades, fruit juices, tomato sauces and basting materials containing acids may cause discoloration and should be wiped up immediately. When the surface is cool, clean and rinse.
- Do not use oven cleaners, cleansing powders or harsh abrasives on the outside of the door.

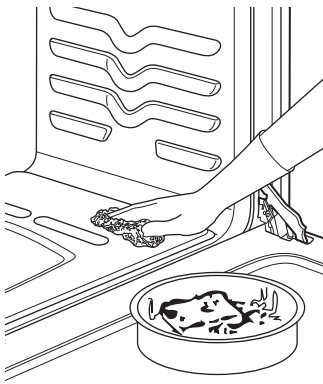

## Porcelain Oven Interior

With proper care, the porcelain enamel finish on the inside of the oven will stay new-looking for years.

Let the range cool before cleaning.

We recommend that you wear rubber gloves when cleaning the range.

### Soap and water will normally do the job.

Heavy spattering or spillovers may require cleaning with a mild abrasive cleaner. Soapy, wet metal pads may also be used. Do not allow food spills with a high sugar or acid content (such as tomatoes, sauerkraut, fruit juices or pie filling) to remain on the surface. They may cause a dull spot even after cleaning.

**Household ammonia may make the cleaning job easier.** Place 1/2 cup in a shallow glass or pottery container in a cold oven overnight. The ammonia fumes will help loosen the burned-on grease and food.

If necessary, you may use an oven cleaner. Follow package directions.

### Cautions about using spray-on oven cleaners:

- Do not spray on the electrical controls and switches because it could cause a short circuit and result in sparking or fire.
- Do not allow a film from the cleaner to build up on the temperature sensor—it could cause the oven to heat improperly. (The sensor is located at the top of the oven.) Carefully wipe the sensor clean after each oven cleaning, being careful not to move the sensor as a change in its position could affect how the oven bakes.
- Do not spray any oven cleaner on the outside of the oven door, handles or any exterior surface of the oven, wood or painted surfaces. The cleaner can damage these surfaces.

## Painted Surfaces

Painted surfaces include the sides, control panel and door. Clean these with soap and water or a vinegar and water solution.

Do not use commercial oven cleaners, cleansing powders, steel wool or harsh abrasives on any painted surface.

## ⚠ WARNING

*Shock or Burn Hazard: Before replacing oven light bulb, disconnect the electrical power to the range at the main fuse or circuit breaker panel. Failure to do so may result in electric shock or burn.*

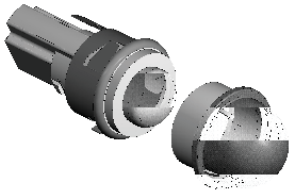

### Oven Light Replacement (on some models)

Be sure to let the light cover and bulb cool completely.

#### To remove the cover:

1. Twist lens counterclockwise about a quarter turn to remove.

Do not remove any screws to remove the cover.

2. Replace bulb with a 40-watt appliance bulb or two-prong halogen bulb, as appropriate.

#### To replace the cover:

1. Line up tabs of lens in front of tabs on housing and rotate clockwise to engage.

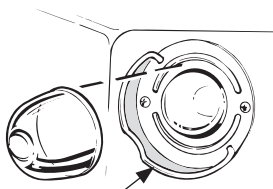

Wire cover holder

### Oven Light Replacement (on some models)

## ⚠ CAUTION

Before replacing your oven light bulb, disconnect the electrical power to the range at the main fuse or circuit breaker panel. Be sure to let the light cover and bulb cool completely.

The oven light bulb is covered with a removable glass cover that is held in place with a bail-shaped wire. Remove the oven door, if desired, to reach cover easily.

#### To remove:

1. Hold a hand under the cover so it doesn't fall when released. With fingers of the same hand, firmly push back the wire cover holder. Lift off the cover.

#### Do not remove any screws to remove the cover.

2. Do not touch hot bulb with a wet cloth. Replace bulb with a 40-watt household appliance bulb.

#### To replace cover:

1. Place it into the groove of the light receptacle. Pull the wire forward to the center of the cover until it snaps into place. When in place, the wire holds the cover firmly. Be certain the wire is in the depression in the center of the cover.
2. Connect electrical power to the range.

# Installation Instructions

# Range

If you have questions, call 1.800.932.4267 or visit our Website at: [www.summitappliance.com](http://www.summitappliance.com)

## In the Commonwealth of Massachusetts

- This product must be installed by a licensed plumber or gas fitter.
- When using ball type gas shut-off valves, they shall be the T-handle type.
- A flexible gas connector, when used, must not exceed 3 feet

## BEFORE YOU BEGIN

Read these instructions completely and carefully.

Installation of this range must conform with local codes, or in the absence of local codes, with the National Fuel Gas Code, ANSI Z223.1/NFPA.54, latest edition. In Canada, installation must conform with the current Natural Gas Installation Code, CAN/CGA-B149.1 or the current Propane Installation Code, CAN/CGA-B149.2, and with local codes where applicable. This range has been design-certified by CSA International according to ANSI Z21.1, latest edition and Canadian Gas Association according to CAN/CGA 1.1 latest edition.

As with any appliance using gas and generating heat, there are certain safety precautions you should follow. You will find these precautions in the Important Safety Information section in the front of this manual. Read them carefully.

**IMPORTANT** — Save these instructions for local electrical inspector's use.

**IMPORTANT** — Observe all governing codes and ordinances.

- **Note to Installer** - Leave these instructions with the appliance after installation is completed.
- **Note to Consumer** - Keep this Owner's Manual and Installation Instructions for future reference.
- **Note** - This appliance must be properly grounded.
- **Service** - The electrical diagram is in an envelope attached to the back of the range.
- Proper installation is the responsibility of the installer.
- Product failure due to improper installation is not covered under the Warranty.

### Mobile Home - Additional Installation Requirements

The installation of this range must conform to the Manufactured Home Construction and Safety Standard, Title 24 CFR, Part 3280 (formerly the Federal Standard for Mobile Home Construction, use the Standard for Manufactured Home Installations, ANSI A225, 1/NFPA 501A or with local codes.

### Mobile home installations require:

- When this range is installed in a mobile home, it must be secured to the floor during transit. Any method of securing the range is adequate as long as it conforms to the standards listed above.

## FOR YOUR SAFETY

Do not store or use combustible materials, gasoline or other flammable vapors and liquids in the vicinity of this or any other appliance.

If you smell gas:

1. Open windows.
2. Don't touch electrical switches.
3. Extinguish any open flame.
4. Immediately call your gas supplier.

## TOOLS YOU WILL NEED



Phillips screwdriver



Flat-blade screwdriver



Pencil and ruler

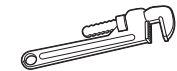

Pipe wrenches (2)  
(one for backup)



Open-end or  
adjustable wrench



Level



Drill, awl or nail

## MATERIALS YOU MAY NEED

- Gas line shut-off valve
- Pipe joint sealant or UL-approved pipe thread tape with Teflon\* that resists action of natural and LP gases
- Flexible metal appliance connector (1/2" I.D.)  
A 5-foot length is recommended for ease of installation but other lengths are acceptable. Never use an old connector when installing a new range.
- Flare union adapter for connection to gas supply line (3/4" or 1/2" NPT x 1/2" I.D.)
- Flare union adapter for connection to pressure regulator on range (1/2" NPT x 1/2" I.D.)
- Liquid leak detector or soapy water.
- Lag bolt or 1/2" O.D. sleeve anchor (for concrete floors only).

\*Teflon: Registered trademark of DuPont

# Installation Instructions

## **WARNING**

### INSTALLATION SAFETY INSTRUCTIONS

**Read these instructions completely and carefully. Failure to follow these instructions can result in electrical shock, fire, serious injury, or death.**

- Improper installation, adjustment, alteration, service or maintenance can cause injury or property damage. Refer to this manual. For assistance or additional information, consult a qualified installer, service agency, manufacturer (dealer) or the gas supplier.
- Never reuse old flexible connectors. The use of old flexible connectors can cause gas leaks and personal injury. Always use **NEW** flexible connectors when installing a gas appliance.
- Leak testing of the appliance shall be conducted according to the manufacturer instructions.
- Remove all packing material and literature from oven before connecting gas and electrical supply to range.
- Do not attempt to operate the oven of this range during a power failure (Electric Ignition models only).
- Have your range installed by a qualified installer.
- Your range must be electrically grounded in accordance with local codes or, in the absence of local codes, in accordance with the National Electrical Code (ANSI/NFPA 70, latest edition). In Canada, electrical grounding must be in accordance with the current CSA C22.1 Canadian Electrical Code Part 1 and/or local codes. See Electrical Connections in this section.
- Before installing your range on linoleum or any other synthetic floor covering, make sure the floor covering can withstand 180°F without shrinking, warping or discoloring. Do not install the range over carpeting unless a sheet of 1/4" thick plywood or similar insulator is placed between the range and carpeting.
- Make sure the cabinets, floor, and wall coverings around the range can withstand heat generated by the range up to 200°F.

- Avoid placing cabinets above the range. To reduce the hazard caused by reaching over the open flames of operating burners, install a ventilation hood over the range that projects forward at least 5" beyond the front of the cabinets.
- The ventilating hood must be constructed of sheet metal not less than 0.0122" thick. Install above the cooktop with a clearance of not less than 1/4" between the hood and the underside of the combustible material or metal cabinet. The hood must be at least as wide as the appliance and centered over the appliance. Clearance between the cooking surface and the ventilation hood surface **MUST NEVER BE LESS THAN 24"**.

**EXCEPTION:** Installation of a listed microwave oven or cooking appliance over the cooktop shall conform to the installation instructions packed with that appliance.

- If cabinets are placed above the range, allow a minimum clearance of 30" between the cooking surface and the bottom of unprotected cabinets.
- If a 30" clearance between cooking surface and overhead combustible material or metal cabinets cannot be maintained, protect the underside of the cabinets above the cooktop with not less than 1/4" insulating millboard covered with sheet metal not less than 0.0122" thick. Clearance between the cooking surface and protected cabinets **MUST NEVER BE LESS THAN 24"**.
- The vertical distance from the plane of the cooking surface to the bottom of adjacent overhead cabinets extending closer than 1" to the plane of the range sides must not be less than 18". (See the Dimensions and Clearances illustration in this section.)

# Installation Instructions

## DIMENSIONS AND CLEARANCES

Provide adequate clearances between the range and adjacent combustible surfaces. These dimensions must be met for safe use of your range.

The range may be placed with 0" clearance below cooktop and at the back wall.

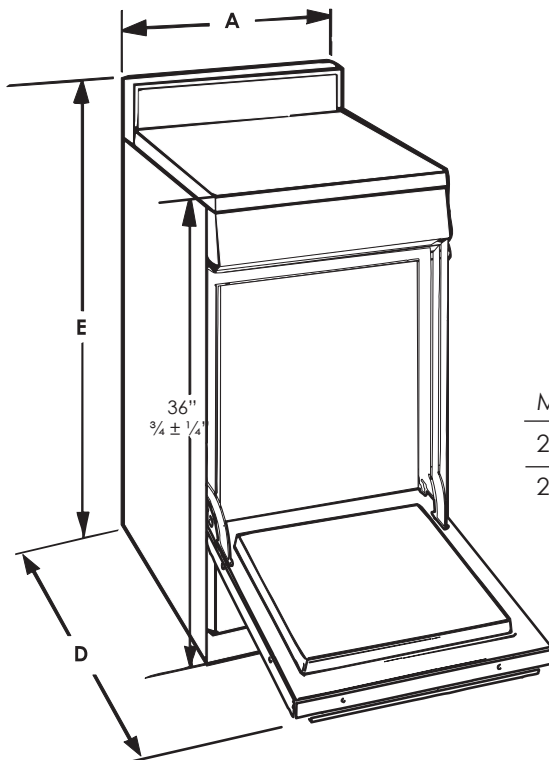
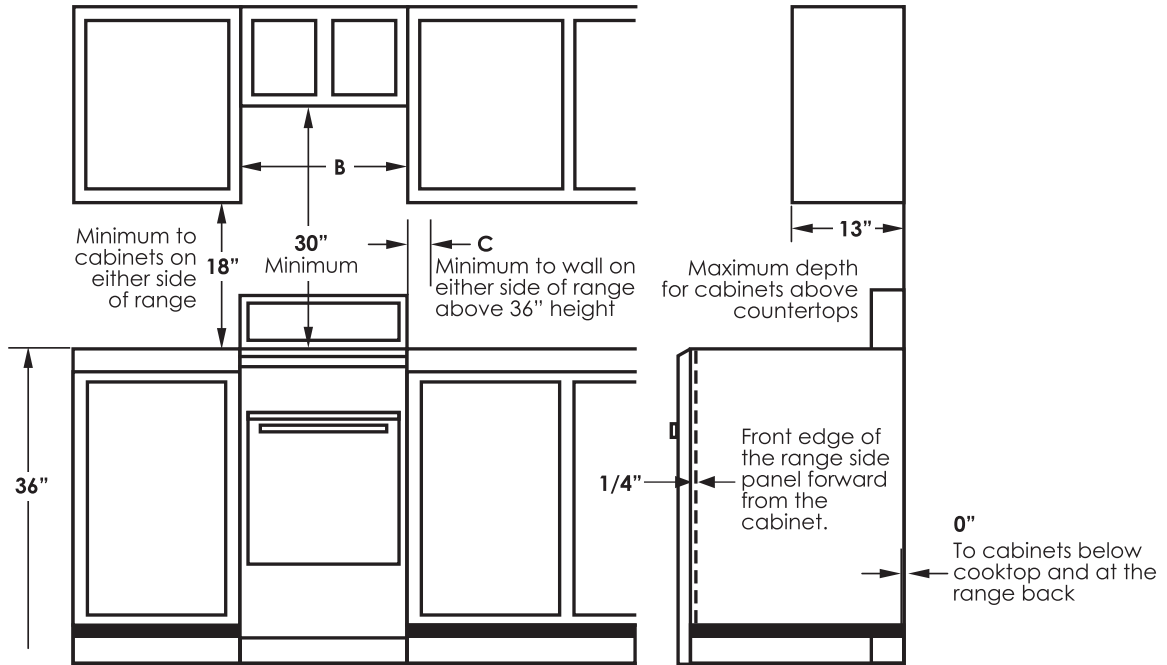

| Models   | A                                | B                                    | C  | D                                | E                                |
|----------|----------------------------------|--------------------------------------|----|----------------------------------|----------------------------------|
| 20" Wide | 19 <sup>3</sup> / <sub>4</sub> " | 19 <sup>3</sup> / <sub>4</sub> " min | 2" | 44 <sup>3</sup> / <sub>8</sub> " | 41 <sup>3</sup> / <sub>4</sub> " |
| 24" Wide | 23 <sup>3</sup> / <sub>4</sub> " | 23 <sup>3</sup> / <sub>4</sub> " min | 2" | 44 <sup>3</sup> / <sub>8</sub> " | 41 <sup>3</sup> / <sub>4</sub> " |

# Installation Instructions

## LOCATION

**Do not locate the range where it may be subject to strong drafts. Any openings in the floor or wall behind the range should be sealed. Make sure the openings around the base of the range that supply fresh air for combustion and ventilation are not obstructed by carpeting or woodwork.**

Your range, like many other household items, is heavy and can settle into soft floor coverings such as cushioned vinyl or carpeting. Use care when moving the range on this type of flooring. It is recommended that the following simple and inexpensive instructions be followed to protect your floor.

The range should be installed on a sheet of plywood (or similar material). When the floor covering ends at the front of the range, the area that the range will rest on should be built up with plywood to the same level or higher than the floor covering.

This will allow the range to be moved for cleaning or servicing. Also, make sure your floor covering will withstand 180°F. (See the Installation Safety Instructions section.)

Make sure the cabinets and wall coverings around your range can withstand the heat generated (up to 200°F) by the range. (See the Installation Safety Instructions section.)

## IMPORTANT!

Remove all tape and packaging. Make sure the burners are properly seated and level.

Take the accessory pack out of the oven and/or drawer.

Check to be sure that no range parts have come loose during shipping.

## 1 PROVIDE ADEQUATE GAS SUPPLY

Your range is designed to operate at a pressure of 5" of water column on natural gas or, if designed for LP gas (propane or butane), 10" of water column.

Make sure you are supplying your range with the type of gas for which it is designed.

This range is convertible for use on natural or propane gas. If you decide to use this range on LP gas, conversion must be made by a qualified LP installer before attempting to operate the range on that gas.

For proper operation, the pressure of natural gas supplied to the regulator must be between 6" and 13" of water column.

For LP gas, the pressure supplied must be between 11" and 13" of water column.

When checking for proper operation of the regulator, the inlet pressure must be at least 1" greater than the operating (manifold) pressure as given above.

The pressure regulator located at the inlet of the range must remain in the supply line regardless of whether natural or LP gas is being used.

A flexible metal appliance connector used to connect the range to the gas supply line should have an I.D. of 1/2" and be 5 feet in length for ease of installation. In Canada, flexible connectors must be single wall metal connectors no longer than 6 feet in length.

# Installation Instructions

## 2 CONNECT THE RANGE TO GAS

**Shut off the main gas supply valve before disconnecting the old range and leave it off until the new hook-up has been completed. Don't forget to relight the pilot on other gas appliances when you turn the gas back on.**

Because hard piping restricts movement of the range, the use of a CSA International-certified flexible metal appliance connector is recommended unless local codes require a hard-piped connection.

Never use an old connector when installing a new range. If the hard piping method is used, you must carefully align the pipe; the range cannot be moved after the connection is made.

To prevent gas leaks, put pipe joint compound on, or wrap pipe thread tape with Teflon\* around, all male (external) pipe threads.

- A. Install a manual gas line shut-off valve in the gas line in an easily accessed location outside of the range. Make sure everyone operating the range knows where and how to shut off the gas supply to the range.
- B. Install male 1/2" flare union adapter to the 1/2" NPT internal thread at inlet of regulator. Use a backup wrench on the regulator fitting to avoid damage.

When installing the range from the front, remove the 90° elbow for easier installation.

- C. Install male 1/2" or 3/4" flare union adapter to the NPT internal thread of the manual shut-off valve, taking care to back-up the shut-off valve to keep it from turning.
- D. Connect flexible metal appliance connector to the adapter on the range. Position range to permit connection at the shut-off valve.
- E. When all connections have been made, make sure all range controls are in the off position and turn on the main gas supply valve. Use a liquid leak detector at all joints and connections to check for leaks in the system.

### **WARNING**

**Fire hazard: Do not use a flame to check for gas leaks.**

When using test pressures greater than 1/2 psig to pressure test the gas supply system of the residence, disconnect the range and individual shut-off valve from the gas supply piping. When using test pressures of 1/2 psig or less to test the gas supply system, simply isolate the range from the gas supply system by closing the individual shut-off valve.

\*Teflon: Registered trademark of DuPont

# Installation Instructions

## RECOMMENDED GAS AND ELECTRIC SUPPLY LOCATION

**NOTE:** Recommended gas hookup locations behind range. Gas fittings and shut-off valve should NOT protrude more than 2" from the wall to allow the range to fit against the wall.

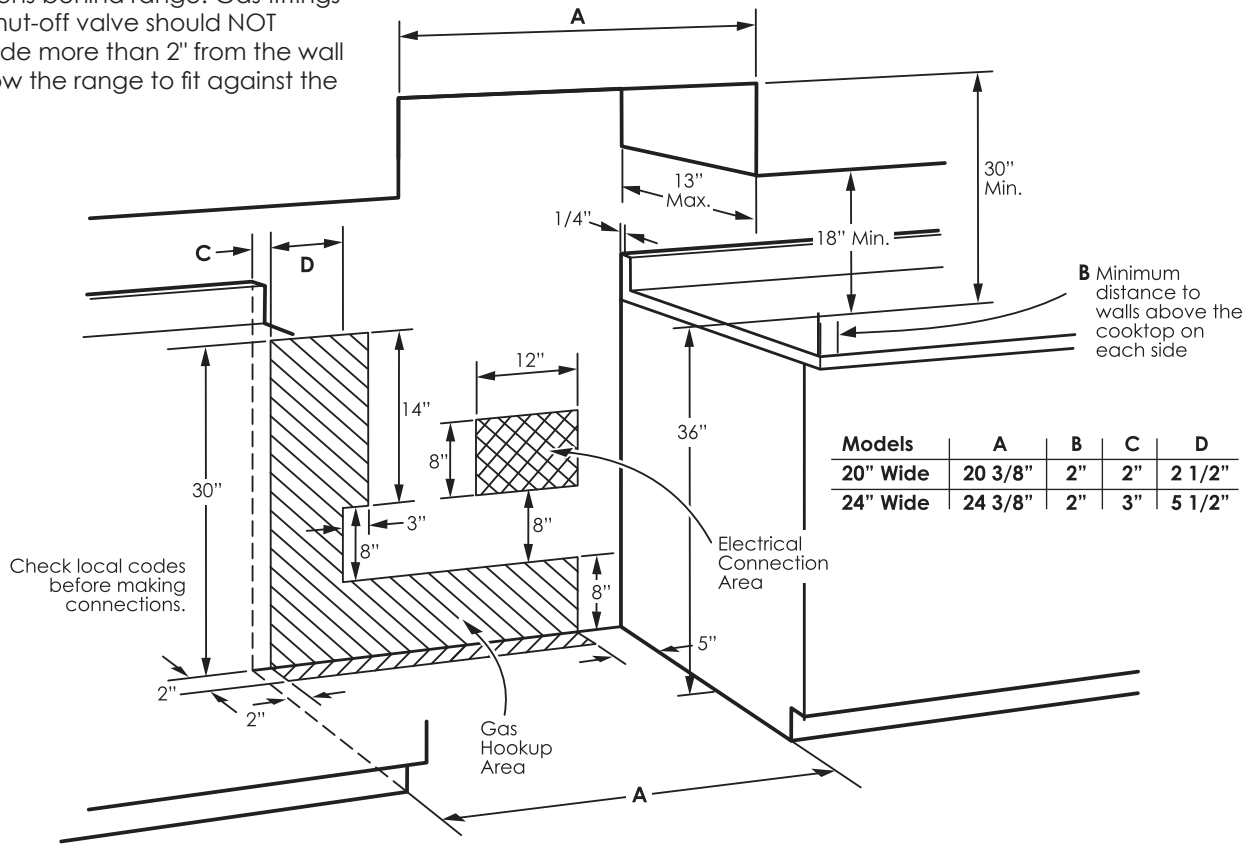

### FLEXIBLE CONNECTOR HOOKUP (Example)

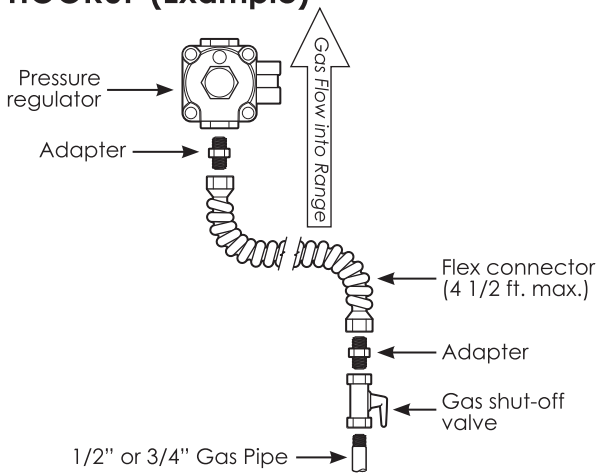

**Installer: Inform the consumer of the location of the gas shut-off valve.**

### RIGID PIPE HOOKUP (Example)

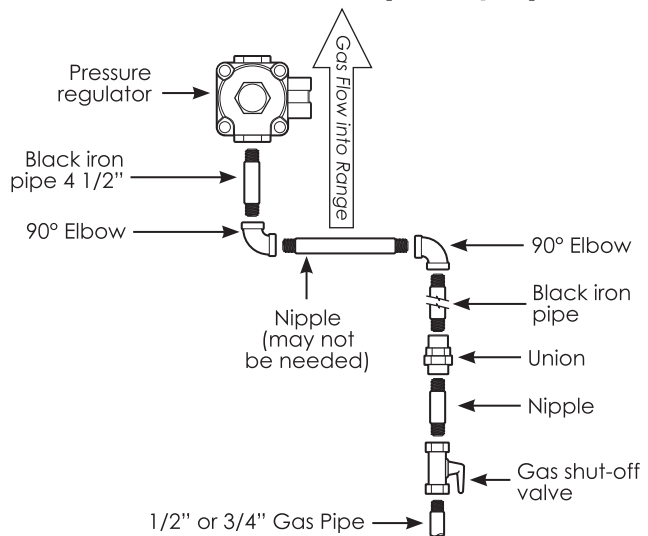

**Installer: Inform the consumer of the location of the gas shut-off valve.**

# Installation Instructions

## 3 ELECTRICAL CONNECTIONS

### Electrical Requirements

120-volt, 60 Hertz, properly grounded dedicated circuit protected by a 15-amp or 20-amp circuit breaker or time delay fuse.

**Note:** Use of automatic, wireless, or wired external switches that shut off power to the appliance are not recommended for this product.

### Grounding

#### **⚠ WARNING**

**Shock Hazard: This appliance must be properly grounded. Failure to do so can result in electric shock.**

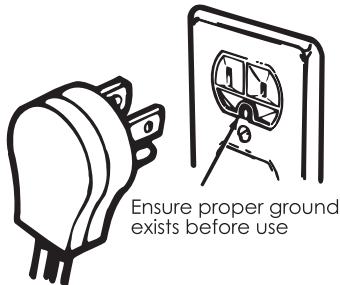

The power cord of this appliance is equipped with a three-prong (grounding) plug which mates with a standard three-prong grounding wall receptacle to minimize the possibility of electric shock hazard from this appliance.

The customer should have the wall receptacle and circuit checked by a qualified electrician to make sure the receptacle is properly grounded.

Where a standard two-prong wall receptacle is encountered, it is the personal responsibility and obligation of the customer to have it replaced with a properly grounded three-prong wall receptacle.

**DO NOT, UNDER ANY CIRCUMSTANCES, CUT OR REMOVE THE THIRD (GROUND) PRONG FROM THE POWER CORD. DO NOT USE AN ADAPTER. DO NOT USE AN EXTENSION CORD.**

**A word about GFCI's - GFCI's are not required or recommended for gas range receptacles.**

Ground Fault Circuit Interrupters (GFCI's) are devices that sense leakage of current in a circuit and automatically switch off power when a threshold leakage level is detected. These devices must be manually reset by the consumer. The National Electrical Code requires the use of GFCI's in kitchen receptacles installed to serve countertop surfaces. Performance of the range will not be affected if operated on a GFCI-protected circuit but occasional nuisance tripping of the GFCI breaker is possible.

## 4 SEAL THE OPENINGS

Seal any openings in the wall behind the range and in the floor under the range when hookups are completed.

## 5 IF THE RANGE HAS ELECTRIC IGNITION

There are separate ignition devices for the left and right hand surface burners. Both of these ignitors are **ON** when any knob is turned to the **LITE** setting. The ignitors will **spark** as long as any of the top burner knobs are at the **LITE** setting.

In the event of an electrical power failure, the top burners can still be used. To light a burner, hold a lit kitchen match adjacent to the top burner to be used and turn valve knob to **LITE**. **USE EXTREME CAUTION.**

## 6 ADJUST THE OVEN BURNER AIR SHUTTER IF NECESSARY

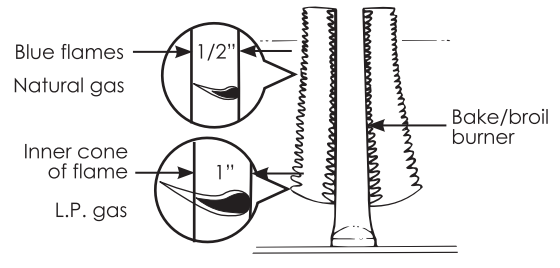

### For Natural Gas:

The oven burner flame should be a clean, blue flame with distinct inner cones approximately 1/2 inch long. A soft, lazy flame with indistinct cones means too much gas or not enough air. A noisy lifting flame means too much air.

# Installation Instructions

## 6 ADJUST THE OVEN BURNER AIR SHUTTER IF NECESSARY (CONT.)

### For LP Gas:

The flame should have approximately 1-inch blue cones. After 30 seconds of burner operation, check for flames lifting off the burner parts. If lifting is observed, gradually reduce the air shutter opening until flames are stabilized. Some yellow tipping may be normal for LP gas.

### If Adjustment is Necessary:

- A** Loosen the lock screw located at the top of the air shutter, then rotate the air shutter to the correct setting and retighten screw.

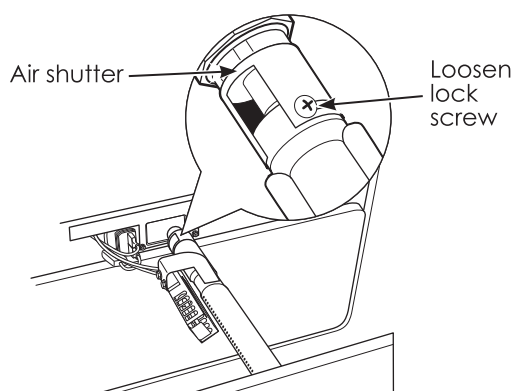

- B** Oven burner flame can be checked as follows (without burner baffle in place):
- To correct a yellow flame—Increase size of air shutter opening.
  - To correct a lifting, but distinct, blue flame—Decrease size of air shutter opening.
- C** The air shutter should be set approximately 2/3 open for natural gas, and approximately full open for LP gas.
- D** The oven burner air shutter adjustment is the same on ranges with a gas pilot or electric ignition.

## 7 QUALITY OF FLAMES

The combustion quality of burner flames needs to be determined visually.



- (A) Yellow flames:**  
Call for service.



- (B) Yellow tips on outer cones:**  
Normal for LP gas.



- (C) Soft blue flames:**  
Normal for natural gas.

If burner flames look like (A), call for service. Normal burner flames should look like (B) or (C), depending on the type of gas you use.

With LP gas, some yellow tipping on outer cones is normal.

## 8 REPLACE OVEN PARTS

After all adjustments are made, replace the oven bottom, shelves and oven door.

# Installation Instructions

## 9 LEVELING THE RANGE

- A. Install the oven shelves in the oven and position the range where it will be installed with front access to front leveling legs and rear access to rear leveling legs. All legs must be leveled BEFORE the product is installed.

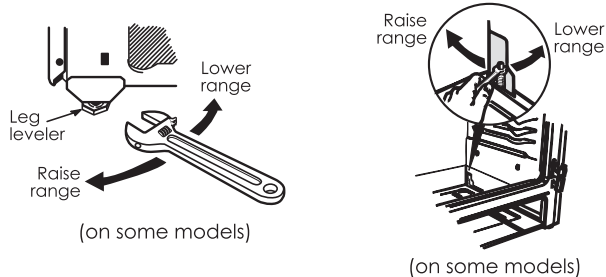

- B. Check for levelness by placing a spirit level or a cup, partially filled with water, on one of the oven shelves. If using a spirit level, take two readings—with the level placed diagonally first in one direction and then the other.
- C. Remove the drawer (on some models). See the Care and cleaning of the range section. The front leveling legs can be adjusted from the bottom and the rear legs can be adjusted from the top (on some models) or the bottom.
- D. Use an open-end or adjustable wrench to adjust the leveling legs until the range is level.

### **⚠ WARNING**

Never completely remove the leveling leg as the range will not be secured to the anti-tip device properly.

- E. After leveling the unit, slide it into final position and verify levelness.
- F. After the range is level, slide the range away from the wall so that the Anti-Tip device can be installed.

## 10 INSTALLING THE ANTI-TIP DEVICE

### **⚠ WARNING** **ANTI-TIP DEVICE**



- All ranges can tip.
- **BURNS** or other **SERIOUS INJURIES** can result.



- **INSTALL** and **CHECK** the anti-tip bracket following the instructions supplied with the bracket.

To reduce the risk of tipping the range, the range must be secured by a properly installed anti-tip bracket. Follow the instructions packaged with the bracket.

To check if the bracket is installed and engaged properly, look underneath the range to see that the rear leveling leg is engaged in the bracket. On some models, the storage drawer or kick panel can be removed for easy inspection. If visual inspection is not possible, slide the range forward, confirm the anti-tip bracket is securely attached to the floor or wall, and slide the range back so the rear leveling leg is under the anti-tip bracket.

If the range is pulled from the wall for any reason, always repeat this procedure to verify the range is properly secured by the anti-tip bracket.

If your range has no anti-tip bracket, call 1.800.932.4267 to receive one at no cost.

## 11 WHEN ALL HOOKUPS ARE COMPLETED

**Make sure all controls are left in the off position. Make sure the flow of combustion and ventilation air to the range is unobstructed.**



## CONVERT TO LP GAS (or convert back to natural gas from LP)

**This range leaves the factory set for use with natural gas. If you want to convert to LP gas, the conversion must be performed by a qualified LP gas installer.**

The conversion instructions and LP orifices can be found attached to the back of the range.

Keep these instructions and the orifices in case you want to convert back to natural gas.

## Before you call for service...

| Problem                                        | Possible Causes                                                                         | What To Do                                                                                                                                                                                                                                                                                                                                                                                                                                                                                                                                                              |
|------------------------------------------------|-----------------------------------------------------------------------------------------|-------------------------------------------------------------------------------------------------------------------------------------------------------------------------------------------------------------------------------------------------------------------------------------------------------------------------------------------------------------------------------------------------------------------------------------------------------------------------------------------------------------------------------------------------------------------------|
| Oven temperature too hot or too cold           | Oven thermostat needs adjustment                                                        | See the <i>Adjust the oven thermostat—Do it yourself!</i> section.                                                                                                                                                                                                                                                                                                                                                                                                                                                                                                      |
| Top burners do not light or do not burn evenly | Plug on range is not completely inserted in the electrical outlet                       | On models with electric ignition, make sure electrical plug is plugged into a live, properly grounded outlet.                                                                                                                                                                                                                                                                                                                                                                                                                                                           |
|                                                | Burner holes on the side or around the top of the burner may be clogged.                | Remove the burners and clean them with a safety pin or paper clip. Make sure you do not enlarge the holes.                                                                                                                                                                                                                                                                                                                                                                                                                                                              |
|                                                | Burners may not be fitted correctly onto mounting brackets.                             | Remove the burners and reinstall them properly.                                                                                                                                                                                                                                                                                                                                                                                                                                                                                                                         |
| Burners have yellow or yellow-tipped flames    | The combustion quality of burner flames needs to be determined visually.                | Use the illustrations below to determine if your burner flames are normal. If burner flames look like <b>A</b> , further adjustment is required. Normal burner flames should look like <b>B</b> or <b>C</b> , depending on the type of gas you use. With LP gas, some yellow tipping on outer cones is normal.<br><br><b>A-Yellow flames</b> Further adjustment required<br><b>B-Yellow tips on outer cones</b> Normal for LP gas<br><b>C-Soft blue flames</b> Normal for natural gas |
| Burner flames very large or yellow             | LP gas is improperly connected.                                                         | Check all steps in the <i>Installation of the range</i> section.                                                                                                                                                                                                                                                                                                                                                                                                                                                                                                        |
| Oven will not work                             | The thermostat capillary bulb must be clean and unobstructed.                           | Make sure the thermostat capillary bulb (located in the upper portion of the oven) is in the correct position, not touching oven sides and not coated with anything.                                                                                                                                                                                                                                                                                                                                                                                                    |
|                                                | The oven vent is blocked.                                                               | The oven vent, on the back of the range, must be unobstructed.                                                                                                                                                                                                                                                                                                                                                                                                                                                                                                          |
|                                                | Oven control improperly set.                                                            | See the <i>Using the oven</i> sections.                                                                                                                                                                                                                                                                                                                                                                                                                                                                                                                                 |
|                                                | Incorrect cookware or cookware of improper size being used.                             | See the <i>Using the oven for baking or roasting</i> section.                                                                                                                                                                                                                                                                                                                                                                                                                                                                                                           |
|                                                | Oven bottom not securely seated in position.                                            | See the <i>Care and cleaning of the range</i> section.                                                                                                                                                                                                                                                                                                                                                                                                                                                                                                                  |
| Strong odor                                    | Improper air/gas ratio in the oven.                                                     | Adjust oven burner air shutter. See the <i>Installation of the range</i> section.                                                                                                                                                                                                                                                                                                                                                                                                                                                                                       |
|                                                | This is temporary.                                                                      | An odor from the insulation around the oven liner is normal for the first few times the oven is used.                                                                                                                                                                                                                                                                                                                                                                                                                                                                   |
| Surface burners light but oven does not        | The oven gas shut-off valve may have accidentally been moved during cleaning or moving. | To check the oven gas shut-off valve on standard twin burner models, raise                                                                                                                                                                                                                                                                                                                                                                                                         |
| Oven light will not work                       | Light bulb is loose or defective.                                                       | Tighten or replace the bulb.                                                                                                                                                                                                                                                                                                                                                                                                                                                                                                                                            |
|                                                | Switch operating light is broken.                                                       | Call for service.                                                                                                                                                                                                                                                                                                                                                                                                                                                                                                                                                       |

**Notes.**

---

**Notes.**

---



FELIX STORCH, INC  
770 Garrison Avenue  
Bronx, NY 10474  
TEL 718-893-3900  
FAX 844-478-8799  
✉ info@summitappliance.com  
www.summitappliance.com

---

## **PARTS AND LABOR WARRANTY INFORMATION**

SUMMIT Appliances are manufactured to provide outstanding value, and your satisfaction is our goal on every product. All SUMMIT major appliances carry a one year limited warranty on both parts and labor. All refrigerators and freezers carry an additional four years on the compressor. Certain exclusions may apply.

### **GENERAL PARTS AND LABOR WARRANTY**

Summit warrants, to the original purchaser of every new unit, that the cabinet and all parts thereof be free from defects in material or workmanship, under normal and proper use and maintenance service as specified by Summit and upon proper installation and start-up in accordance with the instruction packet supplied with each Summit unit. Summit's obligation under this warranty is limited to a period of 12 months from the date of original purchase.

Any parts, covered under this warranty, that are determined by Summit to have been defective, within the above said period, are limited to the repair or replacement, including labor charges, of defective parts or assemblies. The labor warranty shall include pre-approved standard straight time labor charges only and reasonable travel time, as determined by Summit.

### **WARRANTY CLAIMS**

All claims for labor or parts must be made directly through Summit. All claims should include: model number of the unit, the serial number of the cabinet, proof of purchase, date of installation, and all pertinent information supporting the existence of the alleged defect. All claims should be filed within 30 days of completed repair or the warranty claim could be refused.

### **THINGS NOT COVERED BY THIS WARRANTY**

Summit's sole obligation under this warranty is limited to either repair or replacement of parts, subject to the additional limitations below. This warranty neither assumes nor authorizes any person to assume obligations other than those expressly covered by this warranty.

- **NO CONSEQUENTIAL DAMAGES:** Summit is not responsible for economic loss; profit loss; or special, direct, indirect, or consequential damages, including without limitation, losses or damages arising from food or product spoilage claims whether or not on account of refrigeration failure.
- **WARRANTY IS NOT TRANSFERRABLE:** This warranty is not assignable and applies only in favor of the original purchaser/user to whom delivered. Any such assignment or transfer shall void the warranties herein made and shall void all warranties, express or implied, including any warranty of merchantability or fitness for a particular purpose.
- **IMPROPER USE:** Summit assumes no liability for parts or labor coverage for component failure or other damages resulting from improper usage or installation or failure to clean and/or maintain product as set forth in the warranty packet provided with the unit.
- **ALTERATION, NEGLIGENCE, ABUSE, MISUSE, ACCIDENT, DAMAGE DURING TRANSIT OR INSTALLATION, FIRE, FLOOD, ACTS OF GOD:** Summit is not responsible for the repair or replacement of any parts that Summit determines have been subjected after the date of manufacture to alteration, neglect, abuse, misuse, accident, damage during transit or installation, fire, flood, or act of God.
- **IMPROPER ELECTRICAL CONNECTIONS:** Summit is not responsible for the repair or replacement of failed or damaged components resulting from electrical power failure, the use of extension cords, low voltage, or voltage drops to the unit.



FELIX STORCH, INC

770 Garrison Avenue  
Bronx, NY 10474

**TEL** 718-893-3900

**FAX** 844-478-8799

 [info@summitappliance.com](mailto:info@summitappliance.com)

[www.summitappliance.com](http://www.summitappliance.com)

---

- **NO IMPLIED WARRANTY OF MERCHANTABILITY OR FITNESS FOR A PARTICULAR PURPOSE:** There are no other warranties, expressed, implied or statutory, except the parts & labor warranty specifically described above. These warranties are exclusive and in lieu of all other warranties, including implied warranty and merchantability or fitness for a particular purpose. There are no other warranties which extend beyond the description on the face hereof.
- **OUTSIDE UNITED STATES:** This warranty does not apply to, and Summit is not responsible for, any warranty claims made on products sold or used outside the United States.

### **REQUESTING SERVICE**

If you are in need of service, please either fill out a service request on our website, <http://www.summitappliance.com/support>, or call us at 800-932-4267 or 718-893-3900. Please be prepared to give us the following information: your name, address, phone, email, model, serial, date of purchase, place of purchase, and the problem you are having.

### **CALIFORNIA PROPOSITION 65**

**WARNING!** This product may contain chemicals known to the state of California to cause cancer or birth defects or other reproductive harm. For more information, visit: [www.summitappliance.com/prop65](http://www.summitappliance.com/prop65)

Chemicals known by the manufacturer to be present in this product in concentrations higher than threshold limits: NONE.