



www.redgoat.com

ITEM NO. \_\_\_\_\_

## MODEL "A"



"A" Series  
Regular Design  
4 1/2" Throat Size

### "A" SERIES 8" ROTOR



"A" Series  
Regular Design  
7" Throat Size



"A" Series  
Offset Design  
7" Throat Size



HP	SINGLE PHASE		THREE PHASE	
	Volts	Amps*	Volts	Amps*
1 1/2	115	17.2	208	4.9
	230	8.6	230	4.4
			460	2.2
2	115	18.4	208	6.9
	230	9.2	230	6.2
			460	3.1
3	N.A.		208	9.7
			230	8.8
			460	4.4
5	N.A.		208	14.8
			230	13.4
			460	6.7

\*Ratings are for 60 Hz operation

"A" SERIES — BASIC DISPOSER				
Type	Model No.	HP	PH	Throat Size
REGULAR	A112S-R4	1 1/2	1	4 1/2"
	A112S-R7	1 1/2	1	7"
	A112P-R4	1 1/2	3	4 1/2"
	A112P-R7	1 1/2	3	7"
	A2S-R4	2	1	4 1/2"
	A2S-R7	2	1	7"
	A2P-R4	2	3	4 1/2"
	A2P-R7	2	3	7"
	A3P-R4	3	3	4 1/2"
	A3P-R7	3	3	7"
	A5P-R4	5	3	4 1/2"
	A5P-R7	5	3	7"
OFFSET	A112S-O7	1 1/2	1	7"
	A112P-O7	1 1/2	3	7"
	A2S-O7	2	1	7"
	A2P-O7	2	3	7"
	A3P-O7	3	3	7"
	A5P-O7	5	3	7"

#### OPTIONAL FEATURES:

- For Hard Chrome Option, add **HC** to the end of the disposer model number.
- **ADAPTOR KITS:** Adaptor kits are available to allow installation of Red Goat Disposers to virtually any sink or cone size or configuration. Refer to "Adaptor Kit Selection Guide" for specific kit model numbers.

#### PRODUCT INFORMATION:

- **APPLICATION:** Medium size restaurant kitchen. Ideal for vegetable preparation, salad and pot sink areas of large kitchens. Complies with military specifications, including shipboard use. Can be used with salt water applications (specify **HC** option).

#### DESIGN AND CONSTRUCTION:

- Waste chamber design permits dual directional operation when used with reversing control or switch, doubling the life cycle of the shattering mechanism. Regular waste chamber available with either 4 1/2" or 7" throat size.
- Basic body components are cast gray iron, machined, primed and painted. 8" Diameter rotor with (2) bolt-on reversible impact bars and sizing ring are cast ductile iron, machined, balanced and heat treated.
- Flexible drain connector. Fastens quickly to either metal or PVC drain line (2" pipe size).
- Stainless steel legs and feet, adjustable from 0" to 2".
- Disposer connects to Cone or Sink Assembly by means of a neoprene isolation sleeve and (2) stainless steel clamps.
- Offset Design: For maximum space utilization, disposer is also available with an 8" off-set waste chamber for both Cone and Sink attachments. (Available with 7" diameter throat size only.)

#### MOTOR:

- Reversing, continuous duty, 1725 RPM (1425 RPM, 50 Hz), full rated horsepower, double sealed, permanently lubricated ball bearings.
- Thermal overload protection with manual reset button.
- Available for single phase or three phase installations.
- Available in 1 1/2 HP for light waste, 2 HP for standard use, 3 and 5 HP for heavy duty use.
- Dual voltage windings allow multi-voltage operation by motor lead connection. (See Motor Wiring Diagram.)  
115-230 Volts, 60 Hz; 110/220 Volts, 50 Hz, 1 Phase  
208-230/460 Volts, 60 Hz; 190-220/380-440 Volts, 50 Hz, 3 Phase  
(See table for ampere draw per horsepower, volts & phase)



- **CONTROLS: NOTE:** *Electrical switches or control centers not included, must be selected as required.*

### Red Goat Disposers

SOMAT COMPANY  
165 Independence Court, Lancaster, PA 17601  
717-397-5100 — FAX #717-397-1997  
800-237-6628 ext. 181 — www.redgoat.com

**TW Food Equipment Group**

■ **MOUNTING ASSEMBLY OPTIONS:**

SINK ASSEMBLY	CONE ASSEMBLIES
 <p>Mounts to standard sink using our 4½" or 7" Sink Assembly with vinyl silver trap scrapping ring..</p> <p><i>(Sink adaptor ring must be welded into sink.)</i></p> <p>For regular sink attachment. Adjustable leg support.</p> <p><b>Includes:</b> Sink Adaptor, Vinyl Silver Trap Scrapping Ring &amp; Waterflow Controls shown below. <b>(Specify voltage for Solenoid Valve.)</b></p> <p>Order . . . Model No. <b>A-RSA4</b> (4½" throat size) or . . . Model No. <b>A-RSA7</b> (7" throat size)</p>	 <p>Mounts to dishtable or sink using our stainless steel cone with water swirl inlet valve and vinyl silver trap scrapping ring. Our cones are available in three sizes: 12", 15" and 18" diameter, with either 4½" or 7" diameter throat.</p> <p><i>(Cone must be welded into sink.)</i></p> <p>For regular cone attachment to dishtable. Adjustable leg support.</p> <p><b>Includes:</b> Stainless Steel Cone (choice of 12", 15" or 18"), Water Swirl Inlet Valve, Vinyl Silver Trap Scrapping Ring &amp; Waterflow Controls shown below. <b>(Specify voltage for Solenoid Valve.)</b></p> <p>For 4½" Throat Size, Order . . . Model No. <b>A-C412</b> (12" Cone) or . . . Model No. <b>A-C415</b> (15" Cone) or . . . Model No. <b>A-C418</b> (18" Cone)</p> <p>For 7" Throat Size, Order . . . Model No. <b>A-C712</b> (12" Cone) or . . . Model No. <b>A-C715</b> (15" Cone) or . . . Model No. <b>A-C718</b> (18" Cone)</p>

■ **MOUNTING OPTION NUMBERING SYSTEM:**

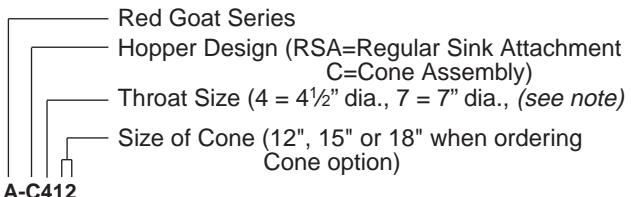

**A-C412**

NOTE: Example shown is a model number for the A Series Cone having a 4½" throat size (throat size must be specified for "A" Series only) and an inside diameter of 12".

■ **WATERFLOW CONTROLS:**



**Flow Control Valve**      **Solenoid Valve**      **Vacuum Breaker**

Each mounting assembly supplied with (1) 8 GPM flow control valve, (1) ½" solenoid valve and (1) ½" vacuum breaker.

■ **INSTALLATION:**

(NOTE: All plumbing and electrical connections shall be made in compliance with applicable local construction codes.)

**PLUMBING:**

Inlet: Cold water supply to disposer shall be ½" service line with a minimum of 20 lbs. flow pressure, piped as close to disposer as possible. All disposer and control connections shall be ½" pipe size.

Sewer Outlet: 2" waste line shall have trap with conveniently located clean out. **Do not connect through a grease trap.** Avoid bends, elbows, tees, etc., to reduce the possibility of plumbing stoppage. A globe valve, used for metering flow must be installed between solenoid valve and cone or sink. Water swirl inlet valves should be located nearest operator.

**ELECTRICAL:**

Follow guidelines set forth in NEC handbook. Disposer branch circuit shall be sized and fused (circuit breakers) as required by motor. The disposer must be connected to a grounded, metal, permanent wiring system; or a disposer-grounding conductor must be run with the circuit conductors and connected to the disposer-grounding terminal or lead on disposer. All connections, junction boxes and conduits must be type NEMA 4 or NEMA 4X.

**TESTING:**

Check for leaks in all plumbing connections. If installed with reversing options, check reversing. If installed with clean out cycle time delay, check two-minute cycle.

# MODEL "A" 8" ROTOR DISPOSER

## ■ INSTALLATION DIAGRAMS:

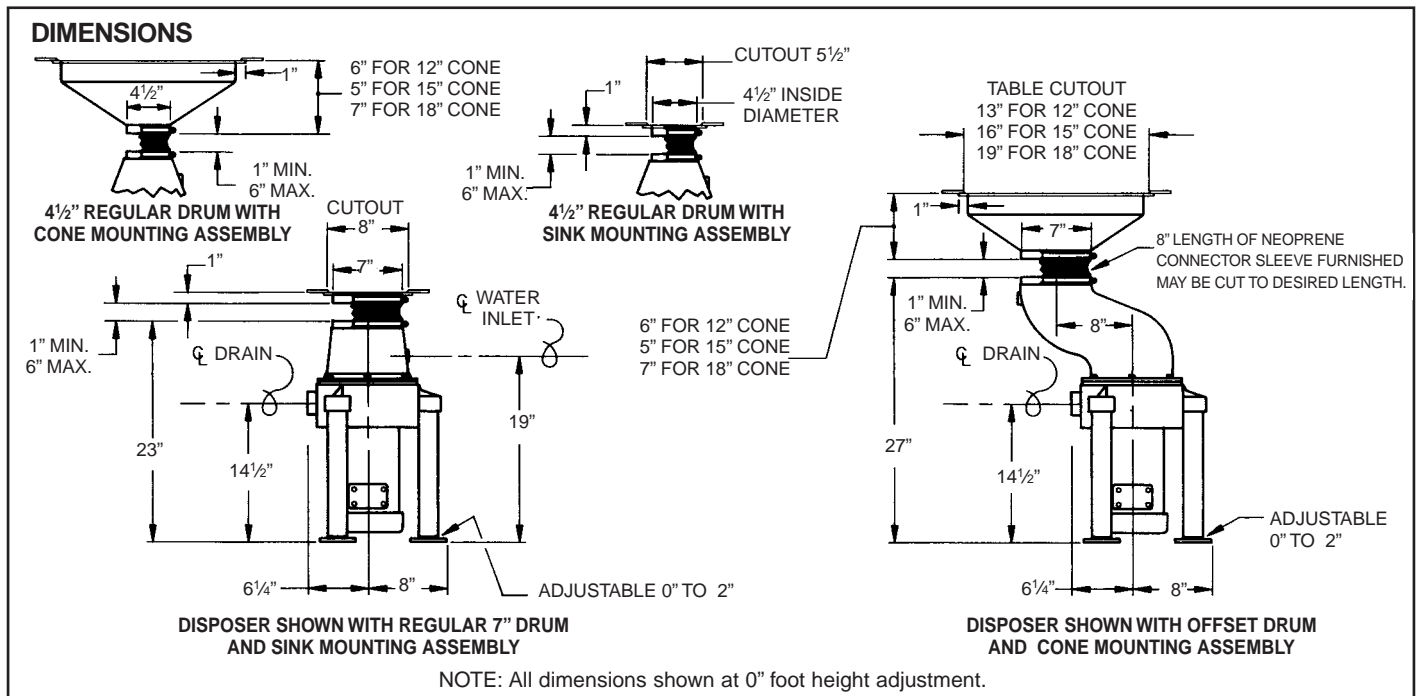

## TYPICAL INSTALLATION

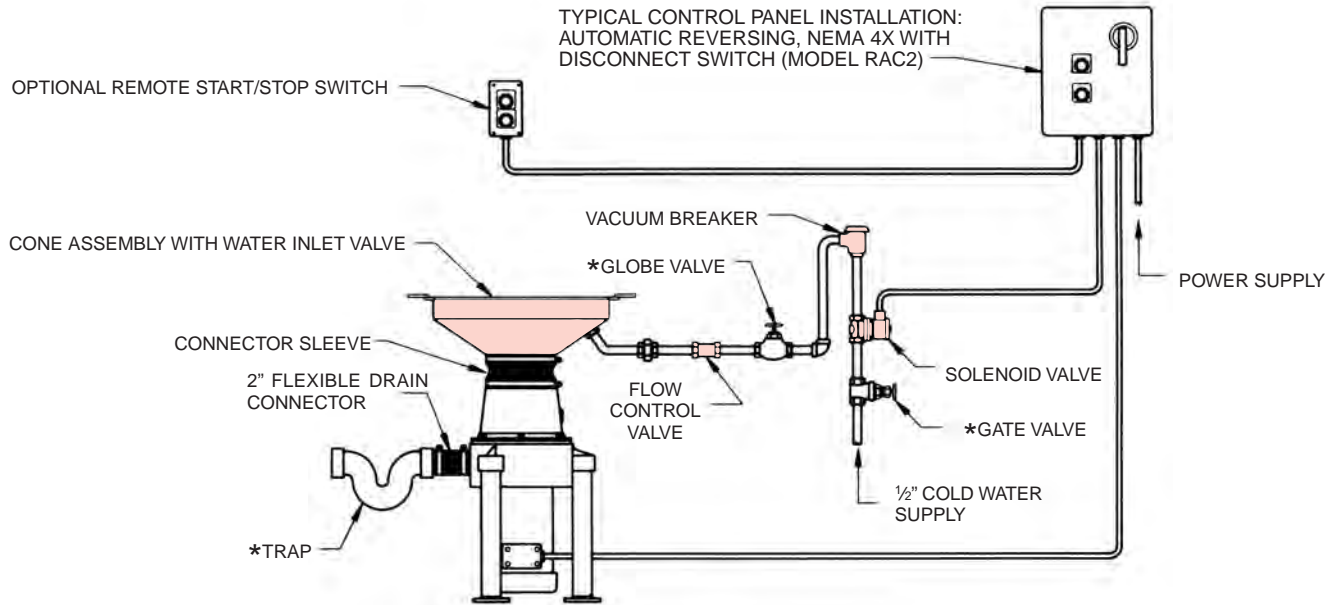

## ■ MOTOR WIRING DIAGRAM:

Also shown on inside of motor connection box cover.

SINGLE PHASE		THREE PHASE	
115 Volt, 60 Hz 110 Volt, 50 Hz	230 Volts, 60 Hz 220 Volts, 50 Hz	208/230 Volt, 60 Hz 190-220 Volts, 50 Hz	460 Volt, 60 Hz 380-440 Volts, 50 Hz
P1 — L1	P1 — L1 P2 — **	T1 — L1 T7 — L1 T4 — * P4 — **	T1 — L1 T7 — * T4 — * P4 — **
T8 — * P2 — * T3 — *	T8 — * T3 — * T2 — *	T2 — L2 T8 — L2 T5 — * P5 — **	T2 — L2 T8 — * T5 — * P5 — **
T5 — L2 T2 — L2 T4 — L2	T5 — L2 T4 — L2	T9 — L3 T6 — * P6 — **	T3 — L3 T9 — * T6 — * P6 — **
	* Tied Together and Insulated ** Insulated		

## ■ INSTALLATION NOTES:

- All electrical connections must be wired per the latest edition of the National Electrical Code and any applicable local codes.
  - All connectors, junction boxes and conduits must be type NEMA 4 (for watertight) or NEMA 4X (for watertight and corrosion resistant) installations.
  - All plumbing must conform to local codes.
  - Basic Disposer Assembly includes disposer, splash guard, mounting screws and 2" pipe size flexible drain coupling with clamps.
  - Main disconnect and branch circuit protection to be provided by others.
- CAUTION:** Non metallic enclosure DOES NOT provide grounding between conduit connectors. Use grounding bushing and jumper wires provided by others.
- \* These items are not supplied by Red Goat Disposers.

# MODEL "A" 8" ROTOR DISPOSER



## BID SPECIFICATIONS: (Example)

Item No. \_\_\_\_\_ Disposer

Disposer shall be Red Goat model A 3P-R7

Construction: Cast iron waste chamber and base. Heat treated ductile iron sizing ring, 8" rotor with (2) reversible impact bars secured with stainless steel screws. Split housing design and flexible drain connection shall permit servicing without breaking plumbing or electric connections. Mounted on three adjustable stainless steel legs with flanged bolt-down feet. Provide with combination face and lip seal for motor moisture protection.

Motor: 3 hp, 460 volts, 60 hz, 3 phase, 1725 RPM. Reversing, continuous duty rated, with double sealed ball bearings.

Approvals and Warranty: Shall be UL (Underwriters Laboratories, Inc.) listed. Warranty shall cover parts, labor and mileage on all components for one year and replacement of basic body components for ten years.

Note: For new installation add one mounting assembly and one control panel.

## WARRANTY:

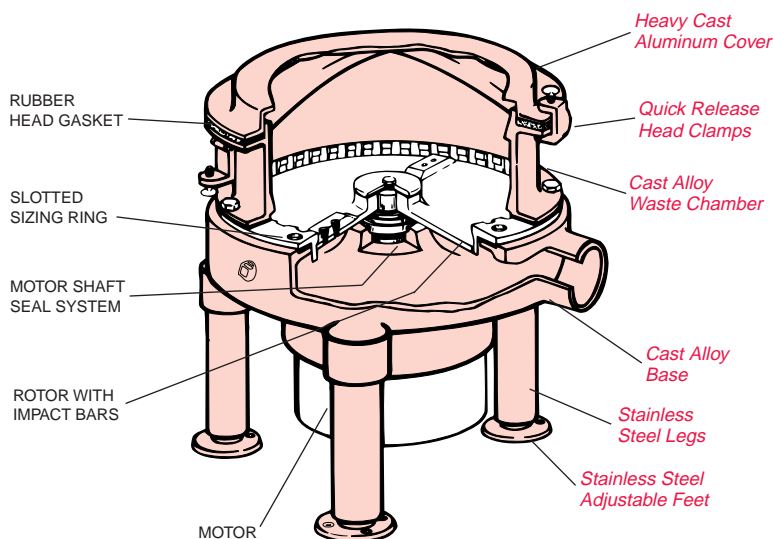

"C" Series disposer pictured.

**STANDARD ONE YEAR WARRANTY**  
All RED GOAT disposer components, shown above in BLOCK print, are guaranteed against all defects for the initial ONE YEAR period of use, as stated in the Warranty.

**RED GOAT TEN YEAR WARRANTY**  
All RED GOAT basic body components, shown above in *italicized* print, are guaranteed to remain serviceable for at least TEN YEARS, as stated in the Warranty.

## SHIPPING DIMENSIONS AND WEIGHTS:

MODEL NO.	WIDTH		DEPTH		HEIGHT		WEIGHT		VOLUME	
	in.	mm	in.	mm	in.	mm	lbs.	kg	cu.ft.	cu.m
A112S-R4	19	483	19	483	30	762	117	53	6.3	.18
A112S-R7	19	483	19	483	30	762	120	55	6.3	.18
A112P-R4	19	483	19	483	30	762	117	53	6.3	.18
A112P-R7	19	483	19	483	30	762	120	55	6.3	.18
A2S-R4	19	483	19	483	30	762	129	59	6.3	.18
A2S-R7	19	483	19	483	30	762	132	60	6.3	.18
A2P-R4	19	483	19	483	30	762	117	53	6.3	.18
A2P-R7	19	483	19	483	30	762	120	55	6.3	.18
A3P-R4	19	483	19	483	30	762	142	65	6.3	.18
A3P-R7	19	483	19	483	30	762	145	66	6.3	.18
A5P-R4	19	483	19	483	30	762	147	67	6.3	.18
A5P-R7	19	483	19	483	30	762	150	68	6.3	.18
A112S-O7	26	660	21	533	29	737	155	70	9.2	.26
A112P-O7	26	660	21	533	29	737	160	73	9.2	.26
A2S-O7	26	660	21	533	29	737	170	77	9.2	.26
A2P-O7	26	660	21	533	29	737	165	75	9.2	.26
A3P-O7	26	660	21	533	29	737	170	77	9.2	.26
A5P-O7	26	660	21	533	29	737	175	80	9.2	.26

*Red Goat is not responsible for any typographical errors. Due to continued product improvement specifications are subject to change without prior notice.*

## Red Goat Disposers

SOMAT COMPANY  
165 Independence Court, Lancaster, PA 17601  
717-397-5100 — FAX #717-397-1997  
800-237-6628 ext. 181 — www.redgoat.com

