

40E Series - Endless Design Single Duty - Red Meat



Model No.	Description	Length	Depth	Height	Voltage	Amps	HP/BTUs	Power Cord	Est. Ship Weight
SC-CMS40E-4-LED	Self Contained	52.5"	40"	53"	115	12.0	1/4	YES	530
SC-CMS40E-6-LED	Self Contained	76.5"	40"	53"	115	12.0	1/3	YES	741
SC-CMS40E-8-LED	Self Contained	100.5"	40"	53"	115	16.0	1/2	YES	983
SC-CMS40E-10-LED	Self Contained	124.5"	40"	53"	115	13.8	1/2	NO	1150
SC-CMS40E-12-LED	Self Contained	148.5"	40"	53"	115	17.4	3/4	NO	1396
R-CMS40E-4-LED	Remote	52.5"	40"	53"	115	0.8	1400	NO	497
R-CMS40E-6-LED	Remote	76.5"	40"	53"	115	1.3	2100	NO	693
R-CMS40E-8-LED	Remote	100.5"	40"	53"	115	1.6	2800	NO	890
R-CMS40E-10-LED	Remote	124.5"	40"	53"	115	2.4	3500	NO	1089
R-CMS40E-12-LED	Remote	148.5"	40"	53"	115	2.4	4200	NO	1325

MODEL NUMBER PREFIX - SC = Self Contained R = Remote
 MODEL NUMBER SUFFIX - W = White B = Black S = Stainless Steel LED = LED lighting
 • Cases are designed to operate at 75 degrees Fahrenheit and 55% relative humidity
 • Cases are equipped with drains; check your local building codes for connection requirements.
 • Specification subject to change without notice
 IF COLORS ARE MIXED AN ADDITIONAL CHARGE WILL APPLY



40E Series - Endless Design Single Duty - Red Meat

Standard Specifications and Optional Features

CONSTRUCTION

- UL Classified to ANSI/NSF 7
- Foamed in place CFC free foam
- Thermal insulated front glass - 28" H
- Heavy gauge steel super structure
- Single duty display
- Endless design allows for continuous line up
- Drain is included for cleaning

INTERIOR

- White, black, and stainless steel ends
- Air insulated baffle (prevents moisture from dripping into display area)

EXTERIOR

- Double pane rear removable doors
- Newly designed rear compression door jamb
- Removable front grille allows for cleaning
- Removable rear grille for easy servicing
- 2 - 1/4" removable end panels
- 1" Front bumper

FINISHES

- White, black, and stainless steel front and ends
- Stainless steel mirror trim
- Stainless steel heavy gauge top - 20" W
- Rear of unit is stainless steel brush finish at top
- Bottom rear is designer white or glossy black

LIGHTING

- 2 rows of LED lighting at top of unit

ELECTRICAL REQUIREMENTS

- 115V, 4', 6', AND 8' with power cord
- Unit must be hard wired, 10' and 12' ONLY
- UL/CUL listed
- 115V-12AMP general purpose receptacle (wired separately) 10' and 12' ONLY

REFRIGERATION

- Copevap system (eliminates need for condensate pan)
- R513A expansion valve system (SC)
- R448A expansion valve system (R)
- Humidity coil located at inside top of unit
- Self contained unit
- Automatic defrost electronically controlled (self contained units only)
- Electronically maintains constant temperatures
- Remotes available

OPTIONS

- Scale stand
- Paper cutter
- Stainless steel, laminate, or paint
- Mirrored doors
- Extra stainless steel mezzanine shelf
- Drop work shelf
- 1" Special color front bumper
- Door locks
- Digital thermometer
- Meat platters
- Red meat bulbs

Important Note:

All refrigerated cases are designed to operate in an environment of 75 degrees and 55% relative humidity. Product must be cooled before being displayed within the case.

DRAIN IS REQUIRED

40E Series - Endless Design Single Duty - Red Meat

Technical Data

Model No.	SC R	SC-CMS40E-4-LED R-CMS40E-4-LED	SC-CMS40E-6-LED R-CMS40E-6-LED	SC-CMS40E-8-LED R-CMS40E-8-LED	SC-CMS40E-10-LED R-CMS40E-10-LED	SC-CMS40E-12-LED R-CMS40E-12-LED
Length with (2) ends		52.5"	76.5"	100.5"	124.5"	148.5"
Length without ends		48"	72"	96"	120"	144"
Height with ends		53"	53"	53"	53"	53"
Height without ends		52.5"	52.5"	52.5"	52.5"	52.5"
Depth with ends		40"	40"	40"	40"	40"
Depth without ends		39.5"	39.5"	39.5"	39.5"	39.5"
Endless design (Dimensions are +/- 1/4")		YES	YES	YES	YES	YES
Operating temperature		34°F to 36°F	34°F to 36°F	34°F to 36°F	34°F to 36°F	34°F to 36°F
Refrigerant (exp. valve)	SC	R513A	R513A	R513A	R513A	R513A
Refrigerant (exp. valve)	R	R448A	R448A	R448A	R448A	R448A
Compressor size HP	SC	1/4	1/3	1/2	1/2	3/4
Defrost per day (24 hours)	Air Defrost	1 per day	1 per day	1 per day	1 per day	1 per day
BTU's at +20°F Evap. Temp.	R	1400	2100	2800	3500	4200
Voltage	SC	115	115	115	115	115
Amperage	SC	12.0	12.0	16.0	13.8	17.4
Remote Voltage	R	115	115	115	115	115
Amperage, lights only	R	0.8	1.3	1.6	2.4	2.4
Cord and plug	SC R	YES NO	YES NO	YES NO	NO NO	NO NO
Exterior color		W,B,S	W,B,S	W,B,S	W,B,S	W,B,S
Interior color		W,B,S	W,B,S	W,B,S	W,B,S	W,B,S
Inside end panels		W,B,S	W,B,S	W,B,S	W,B,S	W,B,S
Floors		W,B,S	W,B,S	W,B,S	W,B,S	W,B,S
# of top doors		2	2	4	4	4
Door size		20.8" x 23.5"	31.3" x 23.5"	20.8" x 23.5"	26.0" x 23.5"	31.3" x 23.5"
# of coils		2	2	2	2	2
Bottom storage		No	No	No	No	No
Front glass		28" x 46.6875"	28" x 70.6875"	28" x 94.6875"	28" x 118.6875"	28" x 142.6875"
# of main deck shelves		2	3	4	5	6
Main deck size		23.5" x 32.62"	23.5" x 32.62"	23.5" x 32.62"	23.5" x 32.62"	23.5" x 32.62"
Cubic capacity		24	36	49	62	74
Mezzanine shelf (Optional)		47.00" x 12.00"	71.00" x 12.00"	(2) 47.00" x 12.00"	(2) 59.00" x 12.00"	(2) 71.00" x 12.00"
Shipping Info						
Height		58"	58"	58"	58"	58"
Depth		47"	47"	47"	47"	47"
Length		61"	87"	109"	135"	157"
Gross weight SC/R		530/497	741/693	983/890	1150/1089	1396/1325
Cubic feet		89	128	164	199	231

(ALL WHITE OR ALL BLACK, NO EXTRA CHARGE—IF COLORS ARE MIXED AN ADDITIONAL CHARGE WILL APPLY)

Prefix

SC = Self Contained
R = Remote

Suffix

B = Black
W = White
S = Stainless Steel
LED = LED lighting

- Cases are designed to operate at 75 degrees Fahrenheit and 55% relative humidity
- Cases are equipped with drains; check your local building codes for connection requirements.
- Specification subject to change without notice

40E Series - Endless Design Single Duty - Red Meat

Technical Data • Side View • Plan View

Side View

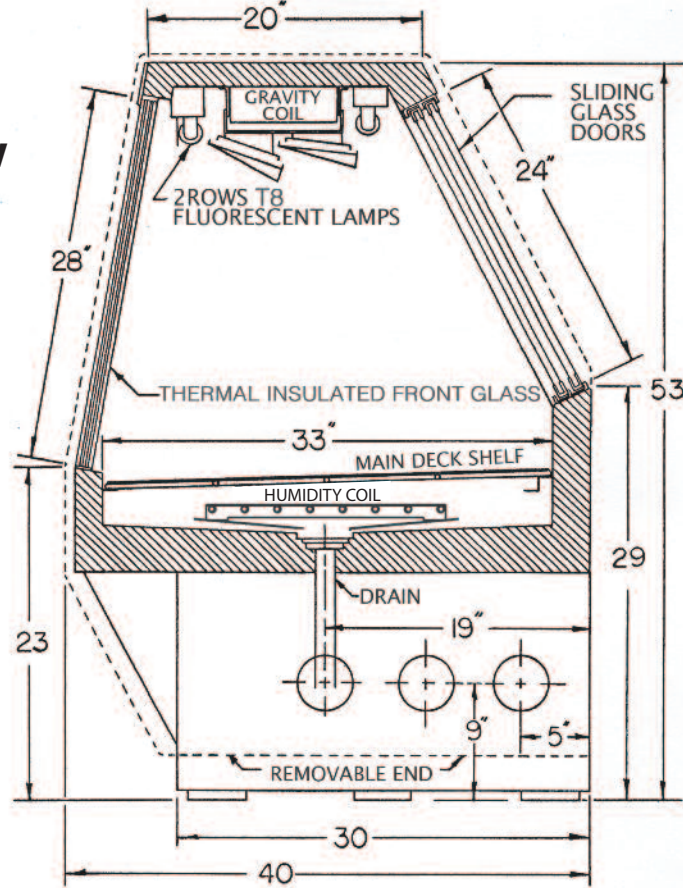

Plan View

