



# HOSHIZAKI

## Service Manual

### Back Bar Equipment

#### Models

HBB-2-59 (-S)

HBB-2-69 (-S)

HBB-3-80 (-S)

HBB-4-95 (-S)

HBB-2G-LD-59 (-S)

HBB-2G-LD-69 (-S)

HBB-3G-LD-80 (-S)

HBB-4G-LD-95 (-S)

## **WARNING**

Only qualified service technicians should install and service the appliance. To obtain the name and phone number of your local Hoshizaki Certified Service Representative, visit [www.hoshizaki.com](http://www.hoshizaki.com). No installation or service should be undertaken until the technician has thoroughly read this Instruction Manual. Likewise, the owner/manager should not proceed to operate the appliance until the installer has instructed them on its proper operation. Failures to install, operate, and maintain the appliance in accordance with this manual may adversely affect safety, performance, component life, and warranty coverage. Proper installation is the responsibility of the installer. Product failure or property damage due to improper installation is not covered under warranty.

Hoshizaki provides this manual primarily to assist qualified service technicians in the service and maintenance of the appliance.

Should the reader have any questions or concerns which have not been satisfactorily addressed, please call, send an e-mail message, or write to the Hoshizaki Technical Support Department for assistance.

Phone: 1-800-233-1940; (770) 487-2331

Fax: 1-800-843-1056; (770) 487-3360

E-mail: [techsupport@hoshizaki.com](mailto:techsupport@hoshizaki.com)

HOSHIZAKI AMERICA, INC.

618 Highway 74 South

Peachtree City, GA 30269

Attn: Hoshizaki Technical Support Department

Web Site: [www.hoshizaki.com](http://www.hoshizaki.com)

**NOTE:** To expedite assistance, all correspondence/communication **MUST** include the following information:

- Model Number \_\_\_\_\_
- Serial Number \_\_\_\_\_
- Complete and detailed explanation of the problem.

## ***IMPORTANT***

This manual should be read carefully before the appliance is serviced. Read the warnings and guidelines contained in this manual carefully as they provide essential information for the continued safe use, service, and maintenance of the appliance. Retain this manual for any further reference that may be necessary.

## **CONTENTS**

Important Safety Information.....	4
I. General Information.....	7
A. Construction.....	7
B. Refrigeration Flow Chart.....	8
II. Sequence of Operation and Service Diagnosis.....	9
A. Sequence of Operation Flow Charts.....	9
B. Service Diagnosis.....	10
C. Controller Check.....	13
D. Thermistor Check .....	14
E. Diagnostic Tables .....	15
III. Controller and Adjustments .....	17
A. Controller with Integrated Display.....	17
1. Controller with Integrated Display.....	17
a) Display Icons .....	17
b) Controller location and Layout.....	18
c) Controller Connections.....	19
B. Temperature.....	20
1. Default Settings.....	20
2. Temperature Setpoint.....	20
3. Changing the Temperature Display Scale (°F or °C).....	21
C. Defrost.....	21
D. Alarm Safeties.....	22
E. Safety Devices.....	22
IV. Replacement of Components .....	23
A. Service for Refrigerant Lines .....	23
B. Important Notes for Component Replacement .....	26
V. Maintenance .....	26
1. Condenser.....	26
2. Power Supply Connection.....	26
VI. Preparing the Appliance for Periods of Non-Use.....	27
VII. Disposal.....	27
VIII. Technical Information.....	28
A. Electrical and Refrigerant Data .....	28
B. Wiring Diagrams.....	29

## Important Safety Information

Throughout this manual, notices appear to bring your attention to situations which could result in death, serious injury, damage to the appliance, or damage to property.

**⚠ WARNING** Indicates a hazardous situation which could result in death or serious injury.

**NOTICE** Indicates a situation which could result in damage to the appliance or property.

**IMPORTANT** Indicates important information about the use and care of the appliance.

### ⚠ WARNING

The appliance should be destined only to the use for which it has been expressly conceived. Any other use should be considered improper and therefore dangerous. The manufacturer cannot be held responsible for injury or damage resulting from improper, incorrect, and unreasonable use. Failure to service and maintain the appliance in accordance with this manual will adversely affect safety, performance, component life, and warranty coverage.

**To reduce the risk of death, electric shock, serious injury, or fire, follow basic precautions including the following:**

- Only qualified service technicians should install and service the appliance.
- The appliance must be installed in accordance with applicable national, state, and local codes and regulations.
- To reduce the risk of electric shock, do not touch the plug or power switch with damp hands.
- Make sure the power switch is in the “OFF” position before plugging in or unplugging the appliance the risk of electric shock.
- Before servicing, move the power switch to the “OFF” position. Unplug the appliance from electrical outlet.
- This appliance requires an independent power supply of proper capacity. See name plate for electrical specifications. Failure to use an independent power supply of proper capacity can result in a tripped breaker, blown fuse, damage to existing wiring, or component failure. This could lead to heat generation or fire.
- **THE APPLIANCE MUST BE GROUNDED:** The appliance is equipped with a NEMA 5-15 three-prong grounding plug  to reduce the risk of potential shock hazards. It must be plugged into a properly grounded, independent 3-prong wall outlet. If the outlet is a 2-prong outlet, it is your personal responsibility to have a qualified electrician replaces it with a properly grounded, independent 3-prong wall outlet. Do not remove the ground prong from the power cord and do not use an adapter plug. Failure to follow these instructions may result in death, electric shock, or fire.

## **⚠ WARNING, continued**

- Do not use an extension cord.
- If the power cord is damaged, replace with factory-specified cord.
- Do not use an appliance with a damaged power cord. The power cord should not be altered, jerked, bundled, weighed down, pinched, or tangled. Such actions could result in electric shock or fire. To unplug the appliance, be sure to pull the plug, not the cord, and do not jerk the cord.
- Do not splash, pour, or spray water directly onto or into the appliance. This might cause short circuit, electric shock, corrosion, or failure.
- Do not make any alterations to the appliance. Alterations could result in electric shock, injury, fire, or damage to the appliance.
- The appliance is not intended for use by persons (including children) with reduced physical, sensory, or mental capabilities, or lack of experience and knowledge, unless they have been given supervision or instruction concerning use of the appliance by a person responsible for their safety.
- Children should be properly supervised around the appliance.
- Do not climb, stand, or hang on the appliance or door or allow children or animals to do so. Do not climb into the appliance or allow children or animals to do so. Death or serious injury could occur or the appliance could be damaged.
- Be careful not to pinch fingers when opening and closing the door. Be careful when opening and closing the door when children are in the area.
- Open and close the doors with care. Doors opened too quickly or forcefully may cause injury or damage to the appliance or surrounding equipment.
- Do not use combustible spray or place volatile or flammable substances near the appliance. They might catch fire.
- Keep the area around the appliance clean. Dirt, dust, or insects in the appliance could cause harm to individuals or damage to the appliance.
- Do not throw anything onto the shelves or load any single shelf with more than 100 lb. (45 kg) of product. They might fall off and cause injury.
- Do not place anything on top of the appliance. Foreign objects or moisture could enter the appliance and result in electric shock or fire.
- The appliance is designed only for temporary storage of food. Employ sanitary methods. Use for any other purposes (for example, storage of chemicals or medical supplies such as vaccine and serum) could cause deterioration of stored items.

## **⚠ WARNING, continued**

- Do not block air inlets or outlets, otherwise cooling performance may be reduced.
- Do not tightly pack the cabinet. Allow some space between items to ensure good air flow. Also allow space between items and interior surfaces.
- Do not store unpackaged product in the appliance; the appliance is for pre-packaged food and beverages only.
- Certain products, if not stored in sealed containers, may accelerate corrosion of the evaporator, resulting in failure; keep all containers closed.
- Do not store items near the air outlet. They might freeze up and crack or break causing a risk of injury or contamination of other food.

## **NOTICE**

- Protect the floor when moving the appliance to prevent damage to the floor.
- Keep ventilation openings, in the appliance enclosure or in the built-in structure, clear of obstruction. Blockage of airflow could negatively affect performance and damage the appliance.
- To prevent deformation or cracks, do not spray insecticide onto the plastic parts or let them come into contact with oil.
- To avoid damage to the gasket, use only the door handle when opening and closing.
- To avoid damage to the top seal, do not lift the appliance by the top panel or remove the top panel.
- Do not leave the doors open

# I. General Information

## A. Construction

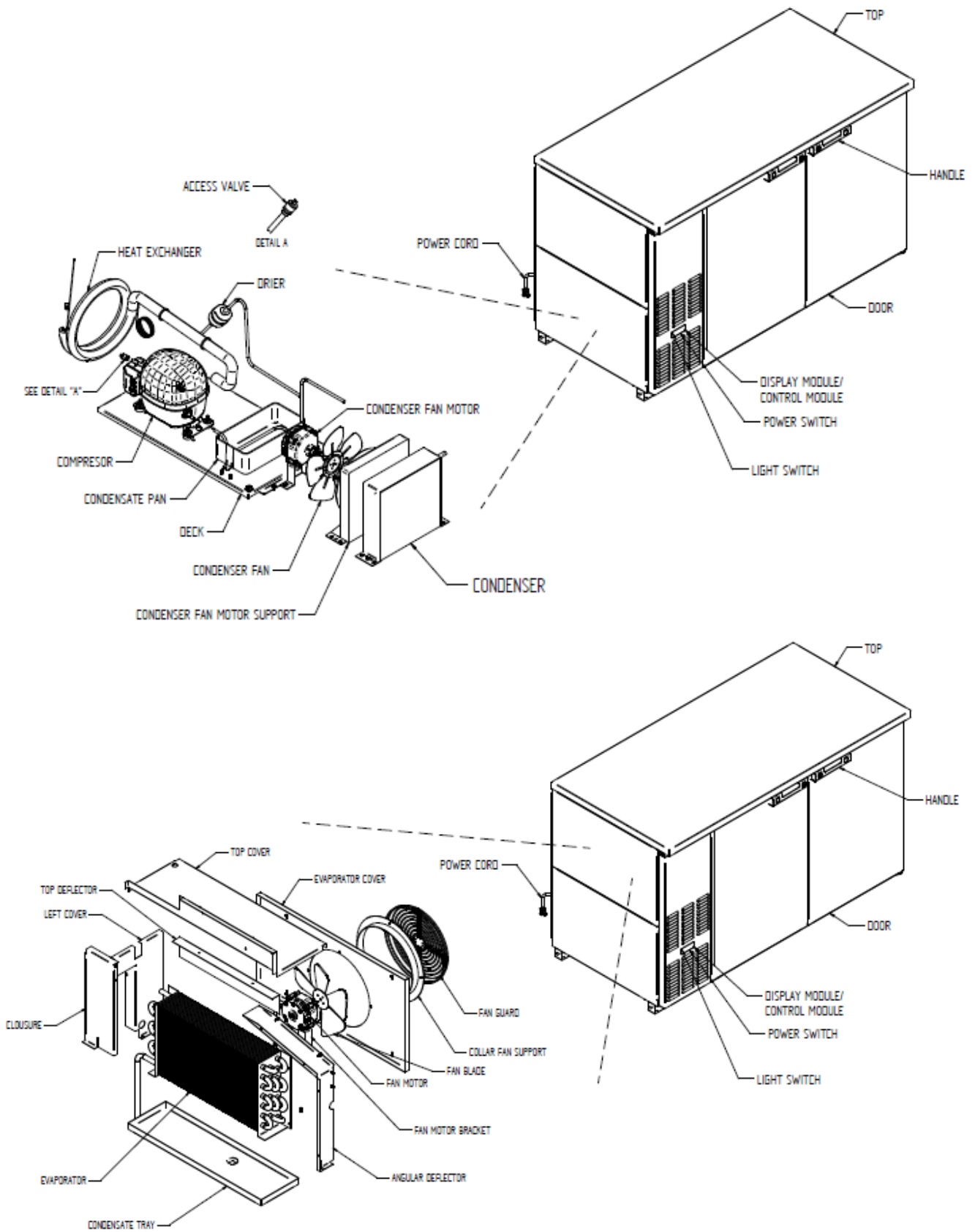

**B. Refrigeration Flow Chart**

**REFRIGERATION FLOW CHART**

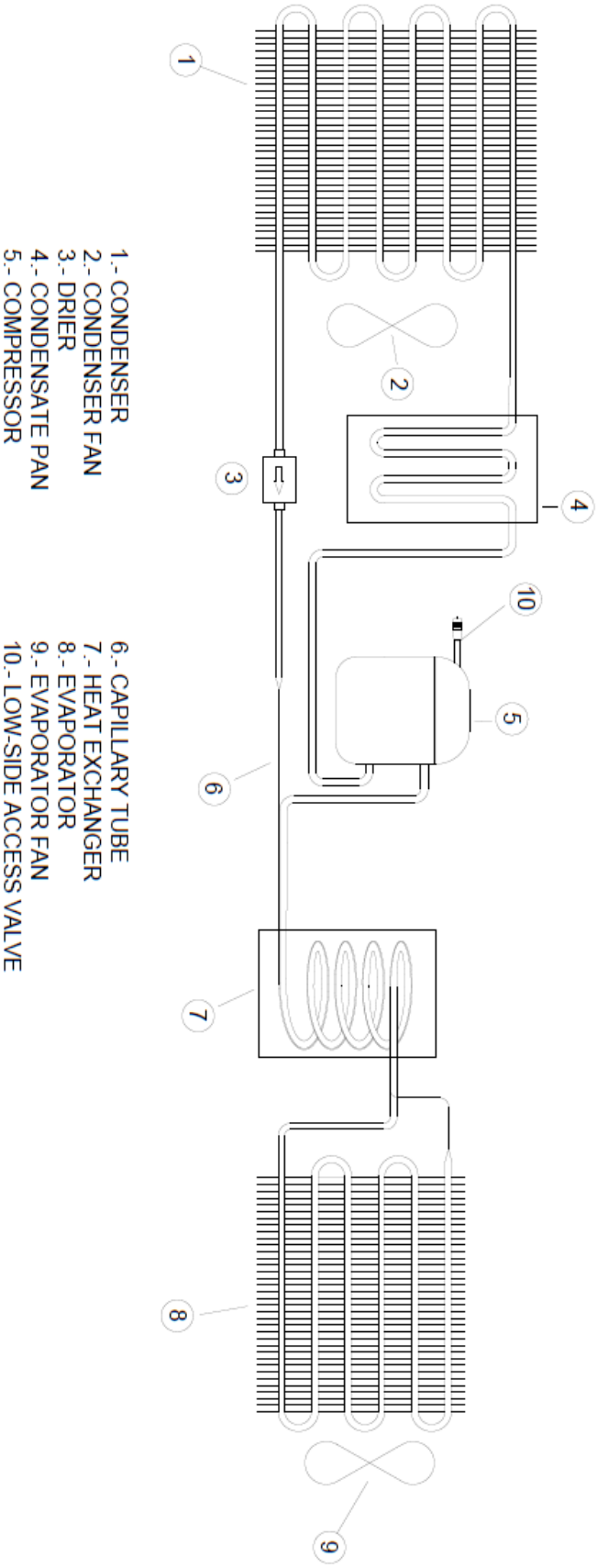

- 1.- CONDENSER
- 2.- CONDENSER FAN
- 3.- DRIER
- 4.- CONDENSATE PAN
- 5.- COMPRESSOR

- 6.- CAPILLARY TUBE
- 7.- HEAT EXCHANGER
- 8.- EVAPORATOR
- 9.- EVAPORATOR FAN
- 10.- LOW-SIDE ACCESS VALVE



## II. Sequence of Operation and Service Diagnosis

### A. Sequence of Operation Flow Charts

#### 1. Refrigerator

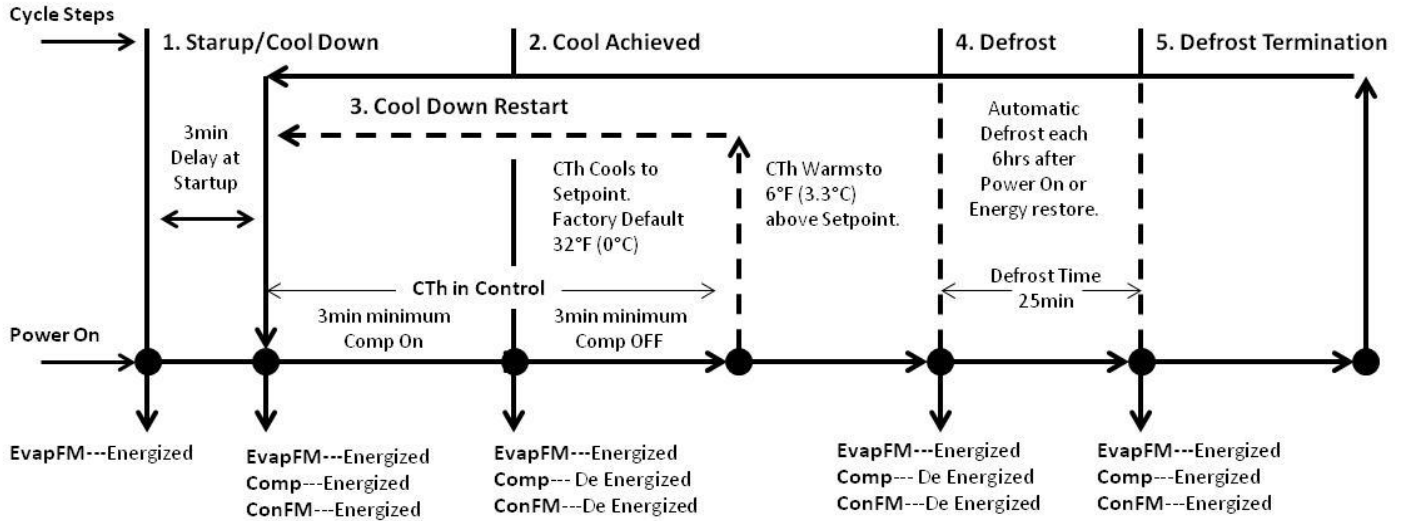

**Legend:**

EvapFM---Evaporator Fan Motor  
 Comp---Compressor  
 ConFM---Condenser Fan Motor  
 CTh ---Cabinet Thermistor

**Note:**

- A) EvapFM Always stay Energized after the Power On
- B) 3-min minimum comp ON timer start when Comp Energized
- C) 3-min minimum comp OFF timer start when Comp De Energized
- D) 25-min Defrost time each 6-hrs, after Power On or energy restore
- E) The temperature displayed when defrost starts is displayed throughout defrost (the temperature on the display does not change during defrost).
- F) After defrost, the temperature on the display changes once the temperature displayed at the start of defrost is reached.

## B. Service Diagnosis

### **⚠ WARNING**

- The appliance should be diagnosed and repaired only by qualified service personnel to reduce the risk of death, electric shock, serious injury, or fire.
- Risk of electric shock. Use extreme caution and exercise safe electrical practices.
- Moving parts (e.g., fan blade) can crush and cut. Keep hands clear.
- Make sure all food zones are clean after the appliance is serviced.

### **NOTICE**

- The appliance is not intended for outdoor use. Normal operating ambient temperature must be within 45°F to 100°F (7°C to 37.4°C).
- The appliance must not be located next to ovens, grills, or other high heat producing equipment.
- The appliance must not be located in a corrosive environment.
- The appliance must be a minimum of 2" (5 cm) from side walls.

The diagnostic procedure is a sequence check that allows you to diagnose the electrical system and components. Before proceeding, check for correct installation and proper voltage per nameplate. Always choose a neutral to establish a good neutral connection when checking high voltages. If the display is in alarm, see "III.D.Alarm safeties".

### **IMPORTANT**

The maximum allowable voltage variation is  $\pm 10$  percent of the nameplate rating. 115VAC is used as a reference voltage when checking voltage to components. Voltage may vary depending on power supply.

## 1. Factory Default Setting:

a) Temperature Settings: **32°F**.

b) Temperature Display Scale: **°F**.

For further details, see "II.C.Controller Check" or "III.Controller and Adjustments."

### **Note:**

- When exposed to high temperatures, a high-temperature alarm "Hi" may occur at startup. To silence the alarm, press and release the "SET" button. Alarm automatically resets when temperature drops to an acceptable range.
- There is a minimum 3-min. Comp on time and 3-min. Comp off time.

1) Move the power switch to the "OFF" position.

2) Unplug the appliance from the electrical outlet.

3) Remove the control box cover.

4) Plug the appliance back into the electrical outlet.

5) Move the power switch to the "ON" position.

6) Confirm 115VAC at the power switch in the top terminal (Brown) and neutral (White), also confirm proper supply voltage at the receptacle box.

7) **Startup/Cool Down** - EvapFM energize. There is a slight delay of 3-min. then Comp and ConFM energize. Cabinet temperature appears in the Display.

a) **EvapFM Diagnosis:** Confirm EvapFM energizes. If not, check for 115VAC at EvapFM terminal connection in Brown and White wire. If 115VAC is not present, check continuity between the Brown wire at power switch at the "ON" position and Brown wire at EvapFM terminal. If there is no continuity, replace the main wiring.

If continuity does exist between the Brown wire in the power switch and the Brown wire at the EvapFM terminal, check that Evap FM is energized and fan blades turn freely, if not, check fan blades for binding and FM winding continuity. Replace as needed.

b) **Controller Diagnosis:** Cabinet temperature appears on Display. If not, check for 115VAC at the controller terminals #6 (Brown) and #7 (White). If 115VAC is not present, check power switch, power cord connections, and breaker/fuse. Confirm wiring connections are secure. If 115VAC is present and the Display is off, replace the controller.

- c) **Comp and CondFM Diagnosis:** Confirm Comp and CondFM energize after the 3-min. of delay at the power on. If not, check if the compressor icon appears in the remote display, if not check the set point and the temperature in the remote display, if the temperature is not in proper range check the CTh status. See "II.D. Thermistor check", If CTh ohm reading is in proper range replace controller.

If the compressor icon appears in the remote display and the set point and the temperature in the display is correct, check If 115VAC is present at the controller terminals #5 (Black Smooth) and #7 (White) If 115VAC is not present, check if 115VAC is present at controller terminals #4 (Black Striped) and #7 (White), if it is present replace the controller.

If the CondFM is energized but Comp is not, check for 115VAC at Comp thermal protector and neutral (White) in the compressor. If 115VAC is not present, give time for Comp thermal protector to cool and reset. If Comp protector does not reset, replace Comp protector. If 115VAC is present, check Comp start capacitor, start relay, and Comp motor windings. If CondFM is not energized, check ConFM fan blades for binding and motor winding continuity.

If Comp and ConFM are energized and the cabinet does not cool down, check for a restriction in the refrigeration circuit, check the suction pressure, and correct refrigerant charge, see "VIII. Technical information".

8) **Cool Down Achieved**-CTh cools to Setpoint of 32°F (0°C). EvapFM continue on, Comp and CondFM de-energize. **Diagnosis:** Confirm Comp and CondFM de-energize. If not, and Comp and CondFM were energized longer than 3-min. check if the Comp icon in the display is off, if the Comp icon is present, check the set point. Check the CTh status. See "II.D. Thermistor Check" If CTh ohm reading is in range and Comp and CondFM continue longer than 3-min., check for 115VAC at the controller terminals #5 (Black Smooth) and #7 (White) If 115VAC is present replace the controller.

9) **Defrost.** There is a 25-min. defrost time each 6-hr. after power on or energy restore.

1b) **Manual Initiation:** To initiate a manual defrost, press and hold the snowflake button for 5 seconds. The snowflake icon appears in the display. EvapFM and LampSW continue energize Comp and CondFM de-energize. The last temperature on display is holding during the defrost time (the temperature do not change on the display during defrost time).

2b) **Manual Termination Defrost:** Press and hold the snowflake button for 5 seconds, the snowflake icon in the display must turn off, and the compressor icon must be blinking in the display, 3-min. Comp delay timer starts, after the delay timers terminate the Comp and CondFM energize.

## **C. Controller Check**

### **1. Controller**

Before replacing Controller that does not show a visible defect and that you suspect is bad, conduct the following check procedure. This procedure will help you verify your diagnosis. Always choose a neutral to establish a good neutral connection when checking high voltages. Also, confirm there is a good power supply and neutral connection to controller: 115VAC at terminals #6 (Brown) to neutral #7 (White).

Alarm Reset: To silence an alarm, press and release the upper or lower button with power on. For alarm information, see "III.D.Alarm Safeties".

### **Startup/Cool Down**

- 1) Check that all wiring connections are properly connected.
- 2) Move the power switch to the "ON" position.
- 3) Check for 115VAC at terminals #6 (Brown) to neutral #7 (White). If 115VAC is not present, check power supply, wiring connections, and power switch continuity.
- 4) Check that the cabinet temperature is displayed on remote display. If not replace the controller.
- 5) Check that Comp icon appears in the display and the Comp and CondFM there is energized. If not, check CTh status. See "II.D.Thermistor Check". If CTh ohm reading is in proper range, check for 115VAC at terminals #5 (Black Smooth) to neutral #7 (White). If 115VAC is not present, replace controller.

### **Defrost**

- 6) Manual Defrost Check: Press and hold the snowflake button until "Snow flake icon" appears on display.
- 7) Confirm Comp, CondFM de-energize. The EvapFM must be energized during defrost time.
- 8) Check that the components restart after defrost termination.

After 25-min of defrost time, the snowflake icon in the display must turn off, and the Comp icon must be blinking in the display, 3-min. Comp delay timer starts, after the delay timers terminate the Comp and CondFM energize.

Legend: Comp-compressor; CondFM-condenser fan motor, EvapFM-Evaporator fan motor, CTh-cabinet thermistor.

## D. Thermistor Check

The cabinet thermistor (NTC type) is used for cabinet temperature control; the thermistor resistance varies depending on temperature. The controller monitors the thermistors to control system operation. No adjustment is required; the controller has the adjustment from factory.

In the event the cabinet thermistor reading is out of range (E0 alarm), the compressor operates on a fixed time basis of 20-min. on and 15-min. off.

To check thermistor resistance, follow the steps below.

- 1) Move the power switch to the "OFF" position, then unplug the appliance.
- 2) Remove the control box cover.
- 3) Disconnect and remove the thermistor.
- 4) Check the resistance between the wires at the thermistor. Normal reading is within 10 k $\Omega$  at 77°F of ambient.
- 6) Reconnect and replace the thermistor in its correct position. See "IV.B. Important Notes for Component Replacement".
- 7) Plug the appliance back in. Move the power switch to the "ON" position.

## E. Diagnostic Tables

Check for correct appliance installation per the instruction manual and proper voltage per appliance nameplate.

### 1. Not Cooling

Not Cooling - Possible Cause	
1. Power Supply	a) Unplugged, off, blown fuse, tripped or defective circuit breaker. On three-section receptacle box, only top receptacles have power.
	b) Loose connection.
	c) Not within specifications.
2. Cord and Plug On three-section model, check receptacle box cord and plug and one-section and two-section cords and plugs	a) Loose connection.
	b) Defective.
3. Power Switch (control box)	a) "OFF" position.
	b) Defective.
4. Wiring	a) Loose connection.
	b) Faulty.
5. Controller, See "III.D. Alarm Safeties" and "II.C. Controller Check"	a) In alarm or "- - -" shown on display.
	b) Defective.
6. Evaporator Fan Motor	a) Defective.
7. Compressor Relay	a) Defective.
8. Compressor Protector	a) Dirty condenser.
	b) Condenser fan motor not operating.
	c) Compressor capacitor or start relay defective.
	d) Defective.
9. Compressor	a) Defective.
10. Condenser	a) Dirty.
11. Evaporator See "II.E.2. Evaporator Frozen Up"	a) Clogged or frozen.
12. Refrigerant/Refrigerant Lines	a) Refrigerant leak.
	b) Refrigerant lines restricted.

## 2. Evaporator Frozen Up

<b>Evaporator Frozen Up - Possible Cause</b>	
1. Evaporator	a) Dirty.
2. Evaporator Fan Motor	a) Fan blades binding.
	b) Defective.
4. Controller	a) Defective.
5. Compressor Relay	a) Defective.
6. Refrigerant Charge/Refrigerant Lines	a) Low.
	b) Component restriction (cap tube, drier).

## 3. Defrost: Controller

<b>Refrigerator Defrost Fails to Initiate - Possible Cause</b>	
1. Compressor Relay	a) Defective.
2. Controller	a) Defective.
	b) Energy loss or restored before the compliance of 6-hr.
<b>Refrigerator Defrost Fails to Terminate - Possible Cause</b>	
1. Compressor Relay	a) Defective.
2. Controller	a) Defective.



### III. Controller and adjustments

#### A. Controller with Integrated Display

##### 1. Controller with Integrated Display

All models are pretested and factory set.

### **NOTICE**

- The controller is fragile, handle very carefully.
- Do not change wiring and connections. Never misconnect terminals.
- Do not short out power supply to test for voltage.

#### a) Display Icons

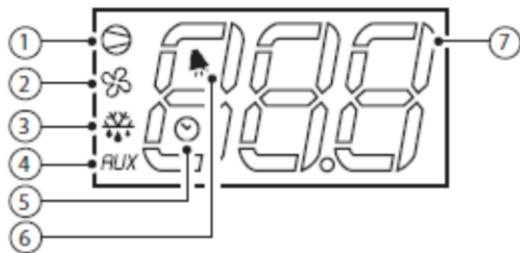
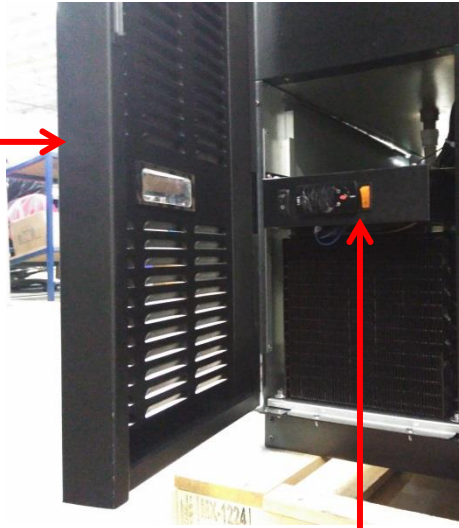

Fig. 3.a

but. no.	function	normal operation			start up		
		ON	OFF	flash			
1	compressor	on	off	call	ON		
2	fan	on	off	call	ON	Not visible in the controller	
3	defrost	on	off	call	ON		
4	auxiliary output (AUX)	output active	output not active	-	ON	Not visible in the controller	
5	clock (RTC)	RTC available, enabled (tEN=1) and at least one time band has been set	RTC not available or not enabled (tEN=0) or no time band set		ON (if the clock is fitted)	Not visible in the controller	
6	alarm	alarm in progress	no alarm in progress	-	ON		
7	digits	three digits with decimal point and range -199 to 999. See parameters /4, /5, /6 for the type of probe displayed, values in °C/°F and decimal point					

## b) Controller Location and Layout

Door to access  
condensing unit and  
control box.



Controller

Controller

Lamp Switch  
Turn On/Off  
The Lamp

Power Switch  
Turn On/Off  
Appliance



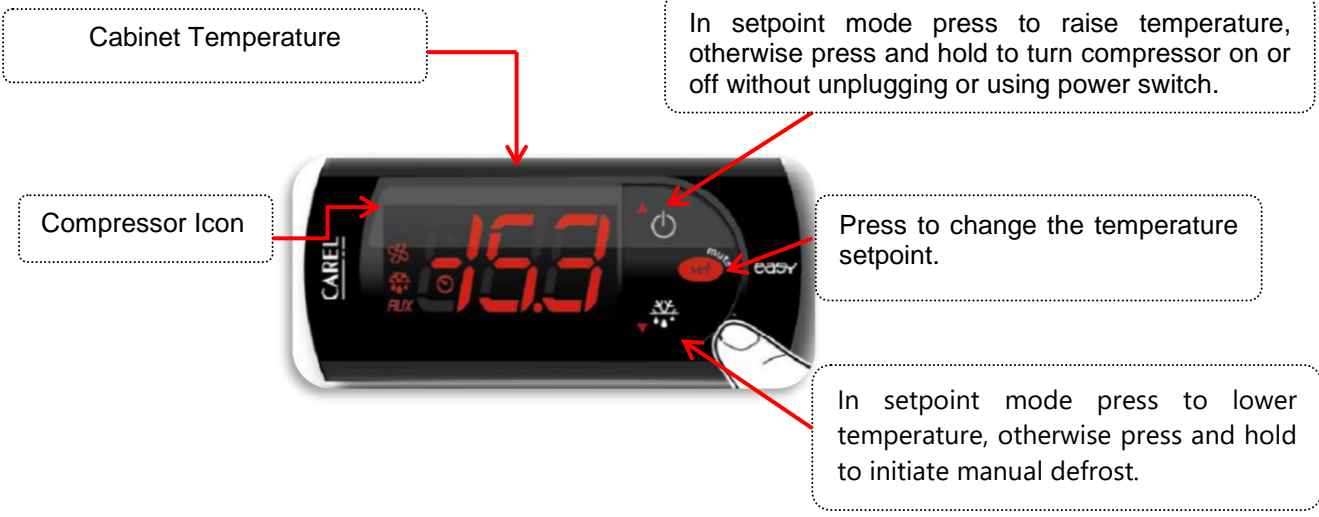

**c) Controller Connections**

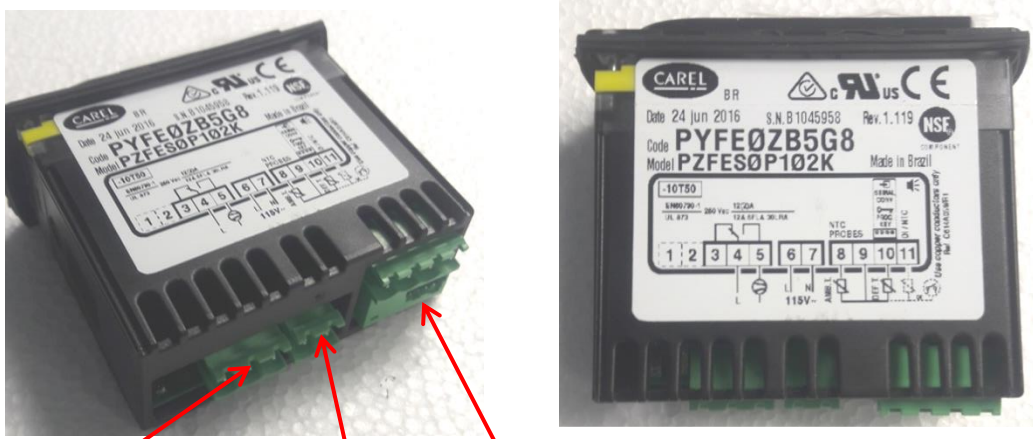

- Compressor Terminals Block 4 & 5
- Power Supply Terminals Block 6 & 7
- Thermistor Terminals Block 8 & 9

## B. Temperature

The temperature default scale is °F, but it can be changed to read °C. To change, see "III.B.3. Changing the Temperature Display Scale (°F or °C)".

### 1. Default Settings

- a) Temperature Setting: 32°F.
- b) Temperature Display Scale: °F.
- c) Differential temperature: 6°F (3.3°C) to turn ON the Comp and CondFM.

### 2. Temperature Set Point

The unit comes with a factory default setpoint of 32°F. If setpoint needs to be changed, follow the steps below.

Press the "SET" button for two seconds. You should see flashing the number 32 (this the default set point). Release the button.



Press the "UP" or "DOWN" arrows arrows to increase or decrease the set temperature. Then press the "SET" button to save the new set point.



#### Note:

The maximum value you can set in the controller is: 36°F.

If you wish to decrease the setpoint, press the DOWN arrow button until you reach the desired value. Release the button and then press the SET button to keep, and save, the new value.



#### Note:

The minimum value you can set in the controller is: 30°F.

### 3. Changing the Temperature Display Scale (°F or °C)

To change from °F to °C, access the controller program mode. Press and hold the "SET" button for 5 sec. "PS" appears in the display. Release the "SET" button. Press the "SET" button again, "0" is displayed. With the "UP" arrow button, scroll until "22" is displayed, then press the "SET" button. "PS" is displayed. With the "DOWN" arrow button, scroll until "EZY" is displayed. Press the "SET" button. "1" is displayed. Press the "UP" arrow button to display the number "2", then press and hold the "SET" button for 5 sec. Temperature is now displayed in the new display scale.

## C. Defrost

### Manual Defrost

To select manual defrost, hold the "DOWN" arrow button for 5-sec. The snow flake icon will appear on the display. When this icon is solid it indicates that the equipment is in defrost mode.



To exit manual defrost, hold the "DOWN" arrow button for 5-sec. The snowflake icon will turn off. Wait 3-min. for the compressor to energize.

## D. Alarms Safeties

Alarm signals are designed to protect the appliance and the beverage product. These alarms give information or warnings in the event the appliance is operating out of acceptable parameters. Should one of the alarms occur, follow the instructions in the table below to address the alarm. The alarm code flashes once every second with audible alarm. To silence the alarm, press and release the “SET” button.

### 1. Controller Module with Integrated Display

<b>Alarm Signals</b>		
<b>Alarm Code</b>	<b>Problem</b>	<b>Corrective action/Reset Details</b>
E0	Cabinet thermistor Malfunction Alarm  Cabinet thermistor has failed	Beeps continually, To silence the alarm, press and release the “SET” button.  Appliance cycles 20-min. on, 15-min. off.
HI	High Temperature Alarm  Cabinet temperature has remained above 57°F (13.9°C) for more than 2hrs	Beeps continually, To silence the alarm, press and release the “SET” button, The alarm icon stays on.  Automatically resets when temperature returns to normal.
LO	Low Temperature Alarm  Refrigerator: Cabinet temperature has remained below 26°F (-3.3°C) for more than 2hrs	Beeps continually, To silence the alarm, press and release the “SET” button, The alarm icon stays on.  Automatically resets when temperature returns to normal.

## E. Safety Device

### 1. Compressor External or Internal Protector

- If combined temperature/amperage value is above the limit specified by the compressor manufacturer, the compressor external or internal protector operates independently to turn off the compressor. The compressor external or internal protector de-energizes the compressor until the temperature/amperage value returns to an acceptable level.
- If the condenser fan motor is operating and the compressor is off, it is most likely that the compressor external or internal protector opened. If both the compressor and condenser fan motor are off, it is most likely the controller failure.
- On refrigerators, the compressor external protector is integrated with the start relay.

### 2. Short-Cycle Protection

There is a 3-min. minimum off-time and on-time for the compressor.

## IV. Replace of Components

### **⚠ WARNING**

- The appliance should be diagnosed and repaired only by qualified service personnel to reduce the risk of death, electric shock, serious injury, or fire.
- Move the power switch to the "OFF" position then unplug the appliance from the electrical outlet before servicing.
- Make sure all food zones in the appliance are clean after the appliance is serviced.

## A. Service for Refrigerant Lines

### **⚠ WARNING**

- Repairs requiring the refrigeration circuit to be opened must be performed by properly trained and EPA-certified service personnel.
- Always recover the refrigerant and store it in an approved container. Do not discharge the refrigerant into the atmosphere.
- Use an electronic leak detector or soap bubbles to check for leaks. Add a trace of refrigerant to the system (if using an electronic leak detector), and then raise the pressure using nitrogen gas (140 PSIG). Do not use R-134a a mixture with pressurized air for leak testing.

### ***NOTICE***

- Do not leave the system open for longer than 15-min. when replacing or servicing parts. The Polyol Ester (POE) oils used in R-134a and R-404A appliances can absorb moisture quickly. Therefore it is important to prevent moisture from entering the system when replacing or servicing parts.
- Always install a new drier every time the sealed refrigeration system is opened.
- Do not replace the drier until after all other repair or replacement has been made. Install the new drier with the arrow on the drier in the direction of the refrigerant flow.
- When brazing, protect the drier by using a wet cloth to prevent the drier from overheating. Do not allow the drier to exceed 250°F (121°C).

## 1. Refrigerant Recovery

The appliance is provided with refrigerant access valves. Using proper refrigerant practices recover the refrigerant from the access valves and store it in an approved container. Do not discharge the refrigerant into the atmosphere.

## 2. Brazing

### **WARNING**

- R-134a is not flammable at atmospheric pressure and temperatures up to 176°F (80°C).
- R-134a is not explosive or poisonous. However, when exposed to high temperatures (open flames), R-134a can be decomposed to form hydrofluoric acid and carbonyl fluoride both of which are hazardous.
- Do not use silver alloy or copper alloy containing arsenic.
- Use an electronic leak detector or soap bubbles to check for leaks. Add a trace of refrigerant to the system (if using an electronic leak detector), and then raise the pressure using nitrogen gas (140PSIG). Do not use R-134a or R-404A as a mixture with pressurized air for leak testing.

- 1) Braze all fittings while purging with nitrogen gas flowing at a pressure of 3 to 4 PSIG.

### **NOTICE**

- Always install a new drier every time the sealed refrigeration system is opened.
- Do not replace the drier until after all other repair or replacement has been made. Install the new drier with the arrow on the drier in the direction of the refrigerant flow.
- When brazing, protect the drier by using a wet cloth to prevent the drier from overheating. Do not allow the drier to exceed 250°F (121°C).

- 2) Use an electronic leak detector or soap bubbles to check for leaks. Add a trace of refrigerant to the system (if using an electronic leak detector), and then raise the pressure using nitrogen gas (140 PSIG). Do not use R-134a or R-404A as a mixture with pressurized air for leak testing.



### 3. Evacuation and Recharge

- 1) Attach a vacuum pump to the system. Be sure the charging hoses are connected to low-side access valves.

<b>NOTICE</b>
---------------

The vacuum level and vacuum pump may be the same as those for current refrigerants. However, the rubber hose and gauge manifold to be used for evacuation and refrigerant charge should be exclusively for POE oils
---

- 2) Turn on the vacuum pump. Open the gauge manifold valves. Never allow the oil in the vacuum pump to flow backwards.
- 3) Allow the vacuum pump to pull down to a 29.9" Hg vacuum. Evacuating period depends on pump capacity.
- 4) Close the low-side valve on the gauge manifold.
- 5) Disconnect the gauge manifold hose from the vacuum pump and attach it to a refrigerant service cylinder. Remember to loosen the connection and purge the air from the hose. See the nameplate for the required refrigerant charge. Hoshizaki recommends only virgin refrigerant or reclaimed refrigerant which meets ARI Standard 700 (latest edition) be used.
- 6) A liquid charge is required when charging an R-134a system. Place the service cylinder on the scales; if the service cylinder is not equipped with a dip tube, invert the service cylinder, and then place it on the scales. Open the high-side valve on the gauge manifold.
- 7) Allow the system to charge with liquid until the proper charge weight is met.
- 8) If necessary, add any remaining charge to the system through the low-side.
- 9) **NOTICE! To prevent compressor damage, use a throttling valve or liquid dispensing device to add the remaining liquid charge through the low-side access valve with the appliance running.**
- 10) Close gauge manifold valves and disconnect the hoses.
- 11) Cap the access valve to prevent a possible leak.

## B. Important Notes for Component Replacement

<b>⚠ WARNING</b>	
<ul style="list-style-type: none"> <li>• When replacing a component listed below, see the notes to help ensure proper operation.</li> </ul>	

Components	Notes
Compressor	Install a new start relay, start capacitor, and compressor protector (compressor protector is integrated with the start relay).
Compressor, Evaporator Fan Motor, Condenser Fan Motor	<b>WARNING! To reduce the risk of electric shock, be sure to reconnect the component's ground wire.</b>
Controller	Be sure all the wiring lines are attached at the correct position on terminals, wait 3-min. to see if the compressors turn on.

## V. Maintenance

<b>⚠ WARNING</b>	
<ul style="list-style-type: none"> <li>• Move the power switch to the "OFF" position and unplug the appliance before performing maintenance to prevent electric shock or injury by moving parts. To reduce the risk of electric shock, do not touch the power switch or plug with damp hands.</li> <li>• Before performing maintenance, move all beverages into another clean refrigerator.</li> </ul>	

### 1. Condenser

Check the condenser once a year and use a brush or vacuum cleaner to clean the condenser as required.

### 2. Power Supply Connection

If a plug, power cord, or receptacle (three-section models) is damaged, replace it. Be sure to connect the ground wire.

## VI. Preparing the Appliance for Periods of Non-Use

### **⚠ WARNING**

- When preparing the appliance for long storage, prevent the doors from closing to reduce the risk of children getting trapped.
- To reduce the risk of electric shock, do not touch the attachment plug or power switch with damp hands.
- When shutting down the appliance for more than one week, move the power switch to the "OFF" position and unplug the appliance.
- Do not plug in/unplug the appliance to start/stop operation. Make sure the power switch is in the "OFF" position before plugging in or unplugging the appliance to reduce the risk of electric shock.

- 1) Before shutting down the appliance, move the stored food into another refrigerator or freezer.
- 2) Open the front panel and move the power switch to the "OFF" position. The appliance will shut down.
- 3) Unplug the appliance.

## VII. Disposal

### **IMPORTANT**

When preparing the appliance for long storage, clean the cabinet interior, door gaskets, and shelves.

### **⚠ WARNING**

When preparing the appliance for disposal, remove the door to reduce the risk of children getting trapped. Leave the shelves in place so that children may not easily climb inside.

The appliance contains refrigerant and must be disposed of in accordance with applicable national, state, and local codes and regulations. Refrigerant must be recovered by properly certified service personnel.

## VIII. Technical Information

### A. Electrical and Refrigeration Data

See the nameplate for electrical and refrigerant data. The nameplate is located inside the cabinet at the left side.

BACK BAR Models (Solid Doors)	Max. Amps	HP	Voltage	NEMA Plug	Breaker Size	Ref. Amount	Ref. Type	Operation Temp		Pressure in Suction Line *
								Cut Out (+/-2°F)	Cut In (+/-2°F)	
HBB-2-59 (-S)	5.1	1/3	115 / 60 / 1	5-15P	15 amp	9.9 oz	134a	32°F	38°F	16-18 PSIG
HBB-3-69 (-S)	5.1	1/3	115 / 60 / 1	5-15P	15 amp	9.9 oz	134a	32°F	38°F	16-18 PSIG
HBB-3-80 (-S)	5.1	1/3	115 / 60 / 1	5-15P	15 amp	9.9 oz	134a	32°F	38°F	16-18 PSIG
HBB-4-95 (-S)	5.1	1/3	115 / 60 / 1	5-15P	15 amp	9.9 oz	134a	32°F	38°F	16-18 PSIG

BACK BAR Models (Glass Doors)	Max. Amps	HP	Voltage	NEMA Plug	Breaker Size	Ref. Amount	Ref. Type	Operation Temp		Pressure in Suction Line *
								Cut Out (+/-2°F)	Cut In (+/-2°F)	
HBB-2G-LD-59 (-S)	5.1	1/3	115 / 60 / 1	5-15P	15 amp	9.9 oz	134a	32°F	38°F	16-18 PSIG
HBB-3G-LD-69 (-S)	5.1	1/3	115 / 60 / 1	5-15P	15 amp	9.9 oz	134a	32°F	38°F	16-18 PSIG
HBB-3G-LD-80 (-S)	5.1	1/3	115 / 60 / 1	5-15P	15 amp	9.9 oz	134a	32°F	38°F	16-18 PSIG
HBB-4G-LD-95 (-S)	5.1	1/3	115 / 60 / 1	5-15P	15 amp	9.9 oz	134a	32°F	38°F	16-18 PSIG

\* Pressure suction measure at 90°F ambient temperature, models ending in -S means stainless steel finish

We reserve the right to make changes in specifications and design without prior notice.

## B. Wiring Diagram

For models:

HBB-2-59 (-S)	HBB-2G-LD-59 (-S)
HBB-3-69 (-S)	HBB-3G-LD-69 (-S)
HBB-3-80 (-S)	HBB-3G-LD-80 (-S)
HBB-4-95 (-S)	HBB-4G-LD-95 (-S)

