



NGW Automatic Wrapping System Operator Manual

ML-44254	NGW1-LI1RL
ML-44255	NGW1-LI1LR
ML-44256	NGW2-LI1RL
ML-44257	NGW2-LI1LR
ML-44280	NGW1-LS2LR
ML-44284	NGW1-LS2RL
ML-44288	NGW2-LS2LR
ML-44290	NGW2-LS2RL
ML-44294	NGW1-LS2RL2P
ML-44295	NGW1-LS2LR2P
ML-44296	NGW2-LS2RL2P
ML-44297	NGW2-LS2LR2P



701 S. RIDGE AVENUE
TROY, OHIO 45374
www.hobartcorp.com

TABLE OF CONTENTS

Chapter 1: Introduction	1-1
Welcome	1-1
FCC Note	1-1
Industry Canada Note	1-1
Verify Correctness of Weight and Price	1-2
Important Information	1-2
Operator Manual Terminology	1-2
Chapter 2: Understanding the System	2-1
Electrical Connections	2-1
Communication Connections	2-2
Operator Screens Overview	2-3
Menu Icon Features	2-7
Keypad and Keyboard Icons	2-9
Understanding the Wrapper	2-9
Selecting Film	2-9
Storing Film	2-9
Using Trays	2-10
Understand Package Weights, Size, Shape and Range Guidelines	2-10
Loading Film	2-11
Chapter 3: Using the NGW Wrapping System	3-1
Using the NGW Wrapping System	3-1
Power Up the System	3-1
Reboot Button	3-2
Shutting Down the System	3-3
Logging onto the System	3-4
Center Operator Screen	3-5
Right Operator Screen	3-6
Modifying the Operator Screens	3-7
Using the Search Function	3-11
Help	3-12
Operation Mode	3-13
Running a Product	3-16
Using Create COOL	3-18
Modifying the Printer Settings	3-19
Selecting Total Types	3-21
Voiding a Transaction	3-21
Rezero the Weigher	3-22
Viewing Product Notes	3-23
Ejecting Media	3-23
Viewing Operator Note	3-24
Viewing Weights & Measures Information	3-25

Viewing About Scale Information	3-26
Using the Flashkey Editor	3-27
Modifying the Wrapper Settings	3-29
Modifying the Label Placement	3-30
Chapter 4: Maintenance & Cleaning	4-1
Cleaning and Maintaining your System	4-1
About Proper Care	4-1
Enemies of Stainless Steel	4-1
Guidelines.	4-2
Cleaning/Rinsing Guidelines	4-3
Sanitizing Guidelines	4-4
Cleaning Instructions	4-4
Cleaning Each Component.	4-5
Component Cleaning Table	4-5
Removing Labels	4-9
Loading Labels.	4-11
Setting the Label Size Plate	4-13
Cleaning the Printhead	4-14
Chapter 5: Troubleshooting	5-1
Troubleshooting	5-1
Reviewing System Errors.	5-3
Possible System Problems	5-11
Chapter 6: NGW (2P) With Secondary Label Applier.	6-1
About the NGW with Secondary Label Applier	6-1
Secondary Labels	6-1
Label Placement Overrides.	6-2
Adding a Secondary Label to a PLU (Temporary Override)	6-4
Index:	I-1

NGW SYSTEM SOFTWARE LICENSE AGREEMENT

This license Agreement describes important rights and obligations governing your use of the software installed on the NGW System ("Product") and related documentation (the 'Software'), which you should read carefully.

LICENSE: You are granted a nonexclusive, non-transferable (except as provided herein), nonsublicenseable, limited license to use the Software in your own business, only installed upon a single Product at any given time. You are permitted to one copy of the Software, only for backup to reinstall the software on the scale or archive purposes in connection with use on the same single Product.

LIMITATIONS; RESTRICTIONS: You have no right to reproduce the Software except for backup or archive purposes as stated above, and no right to distribute the Software or prepare derivative works based on it. You may not use the Software on more than one Product. You shall not, by any leasing, external time-sharing, service bureau or similar arrangement, permit the use of the Software in any business other than your own business. You shall not reverse engineer the Software in any manner, including, without limitation, through decompilation or disassembly.

PROPRIETARY RIGHTS; CONFIDENTIALITY: The Software and all proprietary rights therein, including copyrights and rights under the trade secret laws of any jurisdiction, are the property of ITW Food Equipment Group LLC ("FEG") or the third party owner identified on the Software. You shall not create derivative works based on the Software, it being understood that FEG shall have all right, title or interest in and to all derivative works based upon the Software. Your rights in the Software are limited to those expressly licensed hereby. Any copies which you make of the Software must include all copyright and other proprietary notices included in the original without alteration. You agree not to disclose or otherwise make available the Software to any person other than your employees who require such access in connection with the Software, and shall establish reasonable security precautions to prevent unauthorized disclosure.

TRANSFER: You may transfer the Software to another party only if (i) it is transferred with the Product upon which it was originally installed or accompanied upon delivery; (ii) such party agrees to all terms of this Agreement; (iii) you receive FEG's consent; and (iii) you do not retain any copies of the Software. Any other attempted assignment, sublicense or other transfer of the license granted hereby shall be void.

TERMINATION: The license granted hereby shall terminate upon any failure on your part to comply with the terms hereof. Upon termination, you shall have no further right to use the Software and shall immediately return to FEG or destroy all copies of the Software in your possession. Your obligation of confidentiality with respect to the Software shall survive any such termination.

WARRANTY: Software which is proprietary to FEG is warranted for a period of one year from the date of shipment to function generally in accordance with its documentation, but such functioning is not warranted to be uninterrupted or error-free. Third party Software is warranted for the same period and to the same extent that our licensor has warranted to us. EXCEPT AS EXPRESSLY PROVIDED HERIN, FEG MAKES NO WARRANTIES, EXPRESS OR IMPLIED, WITH RESPECT TO THE SOFTWARE, INCLUDING WITHOUT LIMITATION ANY IMPLIED WARRANTIES OF MERCHANTABILITY OR FITNESS FOR A PARTICULAR USE.

LIABILITY: FEG's sole liability, and your exclusive remedy, for matters relating to the Software shall be the repair or replacement of any software which fails to satisfy the warranty set forth above. You by acceptance of the Software assume liability for any damages which may result from use or misuse of the Software by you or your employees, or by others. EXCEPT AS EXPRESSLY SET FORTH HEREIN, FEG SHALL HAVE NO LIABILITY, IN CONTRACT, TORT OR OTHERWISE, FOR ANY MATTER RELATED TO THE SOFTWARE. IN PARTICULAR, WITHOUT LIMITATION OF THE FOREGOING, FEG SHALL HAVE NO LIABILITY FOR ANY INJURY TO PERSON OR PROPERTY, LOSS OF PROFITS, OR OTHER INDIRECT, INCIDENTAL, SPECIAL OR CONSEQUENTIAL DAMAGES.

CHOICE OF LAW: This Agreement and all acts and transactions pursuant hereto shall be construed and the legal relations between the parties hereto determined in accordance with the laws of the State of Illinois, without regard to the conflicts of laws rules thereof and without regard to the United Nations Convention on the International Sale of Goods.

Chapter 1: Introduction

Introduction

Welcome

The NGW Wrapping System was designed as a meat room or produce back room wrapper. It gives you merchandising capabilities with multiple fonts, graphics, and label types.



NGW Automatic Wrapping System

All necessary operator data appears on the touch screen.

FCC Note

This equipment has been tested and found to comply with the limits for a Class A digital device, pursuant to Part 15 of the FCC rules. These limits are designed to provide reasonable protection against harmful interference when the equipment is operated in a commercial environment. This equipment generates, uses and can radiate radio frequency energy and, if not installed and used in accordance with the instruction manual, may cause harmful interference to radio communications. Operation of this equipment in a residential area is likely to cause harmful interference, in which case, the user will be required to correct the interference at their own expense.

Industry Canada Note

The term “IC:” before the equipment certification number signifies that the Industry Canada Technical Specifications were met.

Verify Correctness of Weight and Price

Routinely verify label information. Check the multiplication of price per pound times weight, and check the scale weight against printed label weight. Weigh the same package several times to verify outcome consistency. Packages that weigh near the middle of the 0.005 lb. increment will vary up or down by 0.005 lb. Variation greater than 0.005 lb indicates the need for weigher adjustment. In such a case, or whenever necessary, contact your local Hobart Representative.

Important Information

The following warnings and notices are provided for your protection:

NOTICE The Model NGW wrapper must be connected to a grounded, metal, permanent wiring system; or an equipment-grounding conductor must be run with the circuit conductors and connected to the equipment-grounding lead on the product.

Operator Manual Terminology

This manual uses the following terminology for keystrokes and data manipulation procedures:

- The word **TYPE** means to touch a series of keys on the Numeric Keypad or QWERTY Keyboard.
- The word **TOUCH** means to activate an entry shown on the display screen.
- The word **SELECT** means to choose one item from a list brought up on the current screen.
- The word **SWIPE** means to touch the screen or the area below the screen and drag in a direction.

The following special instructions are used in the manual:

NOTE: A **Note** is information that you need to know, but is not an actual step in the process.

NOTICE A **NOTICE** is information to alert you that you may be doing something that will permanently alter your system.

⚠ WARNING A **WARNING** indicates a hazardous situation which, if not avoided, could result in serious injury or death.

Chapter 2: Understanding the System

Understanding the System

The NGW Wrapping System is the solution you need to address your back room packaging needs. This state-of-the-art weighing/wrapping system can handle a broad variety of products.

The NGW Wrapping System can store information on thousands of products. Retail store information required for product handling and processing, such as PLU number, UPC number, Pricing, Tare, and Shelf Life can be added. Consumer information describing products, such as NutriFacts, Safe Handling, Expanded Text, Health Tips, Meal Planners, Recipes, Cooking Instructions, and Merchandising Graphics can also be added.

NOTICE

The system should be installed and moved only by qualified Hobart Service Technicians. The system can operate in a temperature range from 32°F to 82°F (0°C to 28°C).

Electrical Connections

A dedicated circuit, rated 120/208-240 volts, 60 Hz, 1 Phase (4-wire 2 hot lines, neutral & ground) with 20 amp circuit protection is required. The wrapper runs on 220 VAC, 1 phase.

The Main Power Switch is located behind the access door located on right-hand side of the lower front panel of the wrapper.

Power runs to the Printer and Console through 110 VAC cables connected in the back of the printer. The Printer must be switched on using the On/Off switch located on the back of the printer. The Printer, Console, and Label Applier do not have power until the On/Off switch is in the ON position.

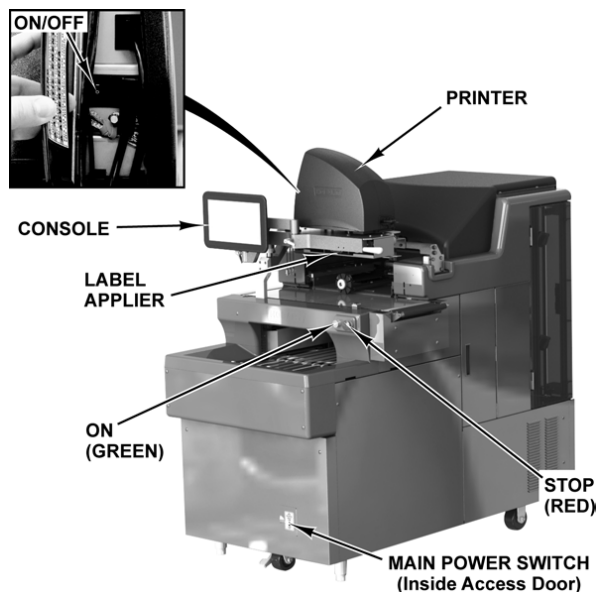

Communication Connections

The following ports are available on the back of the printer.

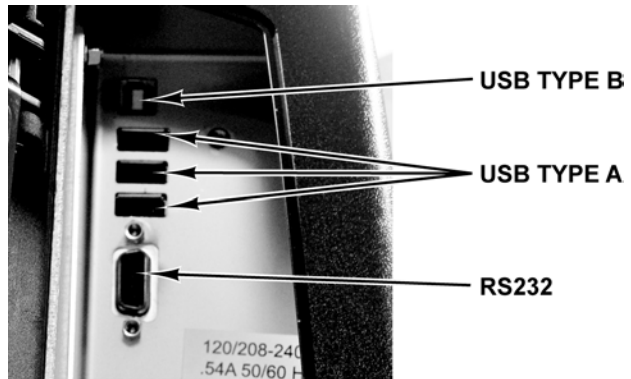

Operator Screens Overview





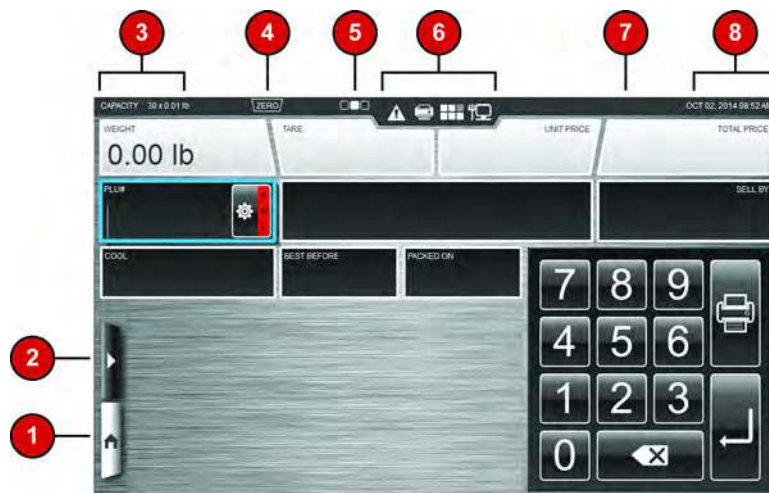

The Operator Screens are touch screens that enable you to enter information and move through the system features. There are three screens as indicated by the Screen View Location icon. TOUCH the left square of the icon to move to the left or the right square to move to the right. You can also TOUCH and SWIPE left to right to move to the left screen or TOUCH and SWIPE right to left to move to the right screen.

The following items will appear on all three screens in the same location. See the *Fixed Features on the Operator Screen* table for detailed information about each feature. The center screen is shown.

1. Home Icon
2. Menu Icon
3. Capacity Information
4. Zero Indicator
5. Screen View Location
6. Alert Section
7. Operator Name, if operator login required
8. Date and Time

NOTE: The location of the information bar across the top can be configured to display across the bottom of the screen. The Menu icon and Home icon can be configured to display on the right side of the screen.



Fixed Features on the Operator Screen		
No.	Feature	Description
1.	Home Icon	This icon will return you to the main page. The main page can either be the left or center screen. This is configured in supervisor mode. If the Home Icon has a small square with an arrow in it, that means that a multimedia file is open. TOUCH the icon  to access the multimedia.
2.	Menu Icon	This icon is the access point to additional system features. See Menu Icon Features for more information.
3.	Capacity Information	This area shows the scale capacity. Current capacity range is shown within a trapezoid.
4.	Zero Indicator	This icon appears when no weight is on the scale and the scale is zeroed.
5.	Screen View Location	This icon shows which of the three screens is displayed. A solid square indicates the current screen.
6.	Alert Section	This section displays four different alerts.
	Product Recall 	This icon will flash red when a product recall message is available. TOUCH the icon to display the message. The icon will remain white when there are no active recalls.
	Printer Alert 	This icon will flash red when there is a printer issue such as the printer is out of labels. TOUCH the icon to display the message. The icon will remain white when no message exists.
	Planogram 	This icon will flash red when a planogram message is available. TOUCH the icon to display the message. The icon will remain white after the planogram has been viewed.
	Network Connectivity	This area will either display a hard wired icon  or will show bar strength  for a wireless connection. If connectivity is lost, the background of the scale application will be red and the icon will be red and flashing. TOUCH to view network details if enabled.
7.	Operator Name	This area shows the operator name, if login is required.
8.	Date and Time	This area shows the current date and time. This information is provided by the operating system.

The left Operator Screen contains the Fixed Features and an area for dynamic content. The dynamic content area can be configured by the system supervisor. See [Using the Flashkey Editor](#) for more information about dynamic content areas.



Left Operator Screen

The center Operator Screen contains the Fixed Features, a numeric keypad if configured, product information, run totals if configured, [Operation Mode](#) settings, and an area for dynamic content. Some information fields such as COOL, Best Before, and Packed On can be turned off by the system supervisor. The dynamic content area and numerical keypad can be configured by the system supervisor. See [Using the Flashkey Editor](#) for more information about dynamic content areas.

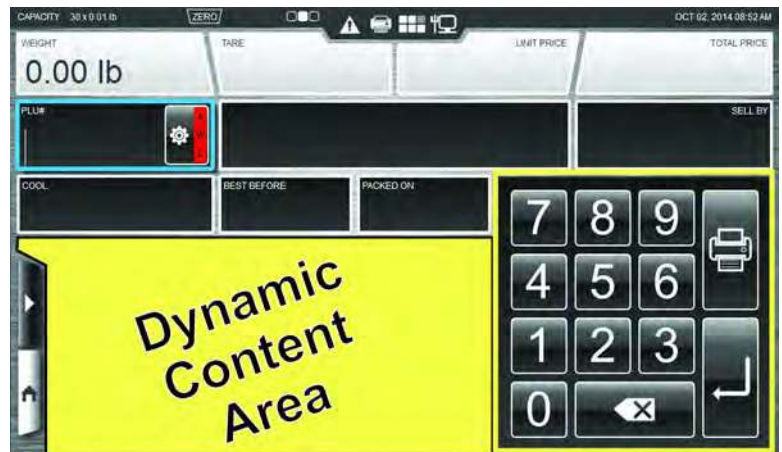

Center Operating Screen

The right Operator Screen can be configured three different ways by the system supervisor. Each option will contain the Fixed Features along with either the wrapper settings, label placement settings, or product and label information.



Right Operator Screen (with product and label information)



Right Operator Screen (with wrapper settings)



Right Operator Screen (with label placement)

Menu Icon Features









The Menu Icon provides the user access to various features of the system. TOUCH the Menu Icon . You should now see the *Menu Window*.



The following items will appear on the Menu Window. See the Menu Icon Features table for detailed information about each feature.





1. Menu
2. Search
3. Language Toggle
4. Help
5. Shutdown Icon
6. Operator Pages
7. Supervisor Pages
8. Service Pages

A blue highlight around the box indicates the feature is selected.

Menu Icon Features			
No.	Feature	Icon	Description
1.	Menu		Default icon to access Operator Pages, Supervisor Pages, or Service Pages.
2.	Search		TOUCH this icon to search for a PLU by name, number, or key word. See Using the Search Function for more detailed information.
3.	Language Toggle		TOUCH this icon to toggle between the available languages on the scale. Scales can be configured to toggle between English/Spanish or English/French. If you have questions about this feature, contact your local Hobart Representative.
4.	Help		TOUCH this icon to access the Operator Manual and training videos.
5.	Shutdown		TOUCH this icon to shutdown or reboot the scale operating system. See Shutting Down the System for more information.
6.	Operator Pages		TOUCH this box to access various operator functions.
7.	Supervisor Pages		TOUCH this box to access supervisor level functions. Detailed information about the Supervisor level functions can be found in the NGW Automatic Wrapping System Supervisor Manual.
8.	Service Pages		This feature is only available to authorized Hobart Service Representatives.

Keypad and Keyboard Icons

Use the following chart to identify icons that appear on the keypad or keyboard. The Keypad is the numerical pad. The Keyboard is the alpha-numeric pad visible when using the search function.

Menu Icon Features		
Feature	Icon	Description
Print		TOUCH this icon to print the label.
Enter		TOUCH this icon to accept information.
Delete		TOUCH this icon to delete entered information. One touch will delete one character. If you touch and hold, it will delete all characters.
Keyboard Close		TOUCH this icon to close the QWERTY keyboard.

Understanding the Wrapper

The wrapper is an automatic stretch wrapper designed to utilize rolled stretch film. The package size is automatically sensed by the wrapper, which then selects the minimum film width and length required to properly wrap each package.

Selecting Film

The wrapping material required is rolled machine stretch film. This wrapper is capable of using 14" to 20" film (width). The size of film required is determined by the size of the package being wrapped. The film must be on 3" cores, and the maximum roll diameter is 9.5". The minimum recommended gauge for the wrapper is 60.

Film widths should allow a 1" overlap on the bottom of the package between flaps. Excessive film width should be avoided because it can cause poor sealing, due to too many folded layers of film under the package.

Storing Film

Film should be stored at temperatures between 50°F and 70°F (10°C and 21°C) with a relative humidity of 50% to 85%. Storage temperatures outside this range can adversely affect film performance and life expectancy.

Using Trays

All products must be contained within a tray in order to be wrapped. The tray design and material must be strong enough and rigid enough to be used for machine wrapping. Damp or soft trays will not work properly and can cause package jams and loss of product.

For best results, the bottom of the tray should be flat. Trays which are distorted or have irregular bottoms cause problems with package movement and film sealing. Trays must have an angled edge of not less than 15° to allow the rear underfolder to roll under the package while wrapping the film under the tray.

The maximum tray width is 15.5" and the maximum length is 10". The minimum tray width is 4.5" and the minimum length is 4.5". Trays less than 1/2" high are not recommended. Flat boards or paper stripping are not acceptable containers.

Understand Package Weights, Size, Shape and Range Guidelines

The performance of your wrapping system is partially dependent on the package size and shape. Bulky or odd shaped packages tend to roll and do not wrap properly.

Package length is defined as the shortest side of the tray. Package length must always exceed package height. If the package is high, but short, it may roll over as it travels through the wrapper.

Uneven distribution of product weight in a package may result in improper sealing or packages turning over. If the package is heavy on one side, it should be placed in the machine with the heavy side away from the operator.

Product must be completely within the tray. Overhanging or projecting parts could cause package jams resulting in damage to the system and loss of time and product.

Loading Film

Keep the film as straight as possible through the threading process. The following diagram shows the different ways to load film.

NOTE: Some wrappers only have one spool for film. The following instructions show a two spool system. The one spool system is similar.

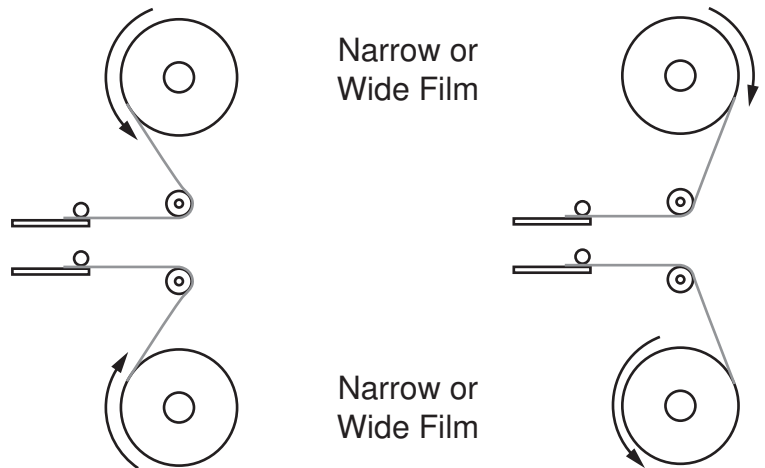

1. PRESS the STOP (red) button and allow the machine to stop.
2. Open the rear doors.
3. Release feed rollers by pulling the film lever down.



4. Turn film supply knob counterclockwise until roll locks are open 1 to 2 inches wider than the roll width.

⚠ WARNING

The film roll is under slight tension. Use care when depressing the roll locks to avoid pinching hands.

5. Depress the roll locks and remove the empty film roll.

⚠ WARNING

The roll locks are spring loaded. Use care when loading film roll onto to the shaft to avoid pinching hands.

6. Firmly slide the film roll onto the shaft, past the roll locks; then tighten the knob as much as possible turning clockwise. The roll will automatically center itself as you tighten the knob.
7. Slide the film tray out, exposing the film combs.
8. Pull the film end in a downward direction (loading top roll) or upward (loading lower roll) to the front of the guide shaft continuing around the shaft toward the extended film tray.

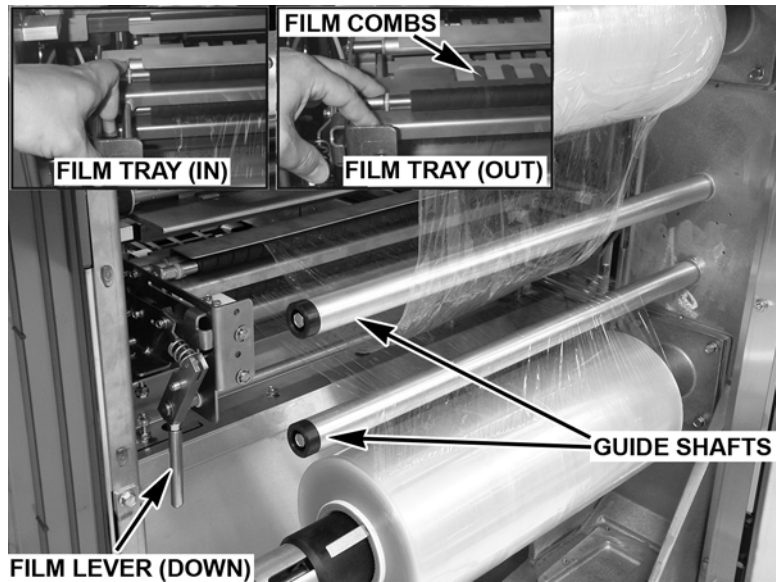

9. Put the film over the tip of your fingers and push through the opening, between the metal and rubber rollers. Make sure the film gets to the ends of the film combs, securing the film end down over the combs.
10. Pull the film lever upward, ensuring its full engagement.

11. Close the rear doors.
12. PRESS the ON (green) button. Wait for a steady light, no blink mode.
13. From any screen, TOUCH the Menu Icon . TOUCH Wrapper Settings.



14. You should now see the *Wrapper Settings Screen*.



NOTE: Depending on the configuration of the wrapper, there may be only one film width listed.

15. If the film width installed is different than the displayed width, SELECT the film width and TOUCH the Load button beside film width.
16. The wrapper will position film, cut any excess film and set itself (home) for operation.
17. TOUCH home icon to exit this screen.
18. PRESS the STOP (red) button and allow the machine to stop.
19. Lift the canopy and remove excess film.
20. Close canopy.
21. PRESS the ON (green) button. It will be a steady light, no blink mode. Ready for operation.

Chapter 3: Using the NGW Wrapping System

Using the NGW Wrapping System

The instructions for using the NGW Automatic Wrapping System are detailed in this chapter.

Power Up the System

To power up the system, use the ON/OFF switch located at the back of the printer.

1. Verify that the main power switch is on, located behind small access door on the right-hand side of the lower panel.
2. PRESS the ON (green) button.
3. Remove any objects from the scale platter/weigher.
4. Turn printer on.

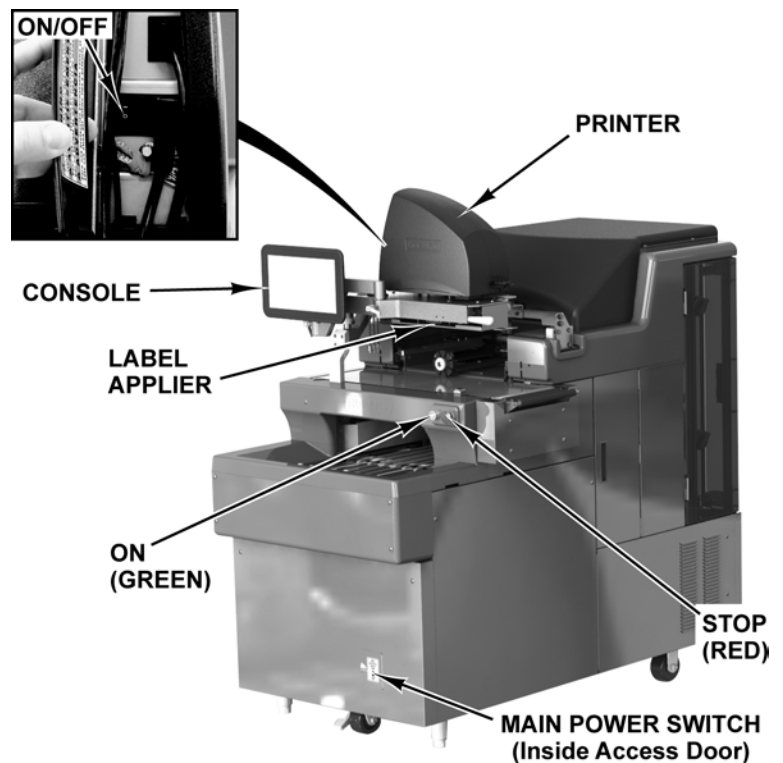

Reboot Button

The Reboot Button is located behind the small access door on the upper left-hand side of the front panel.

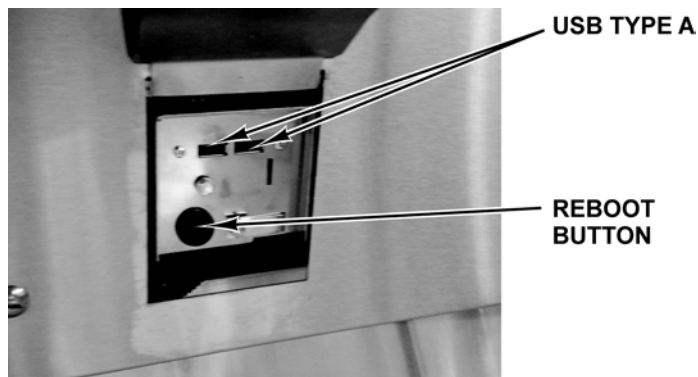

In the unlikely event the system stops responding, use the Reboot Button to reboot the system.

Press and hold the Reboot Button. A screen will appear and say, “The scale is shutting down.”



NOTICE Pressing the Reboot Button should only be used when the system has stopped responding.

NOTICE The reboot button on the wrapper shuts down the operating system only. Power will still be supplied to the console & printer. Do not remove power from the system by unplugging it. Always use the on/off switch on the back of the printer to power down the system.

Shutting Down the System

The Shutdown feature is designed to stop all internal functions. Shutdown is required before power can be disconnected from the system.

To Shutdown the System:

1. TOUCH the Menu Icon .
2. TOUCH the Shutdown Icon .
3. Screen will appear and ask “Are you sure you want to shutdown?”

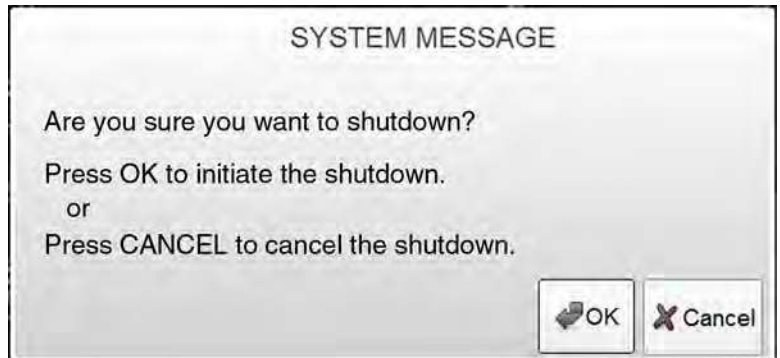

4. TOUCH OK.
5. When the system is ready to shutdown, a screen will appear and say, “The scale application is ready to shutdown. Press the Shutdown button to power down the scale or Reboot to restart.” TOUCH Shutdown.

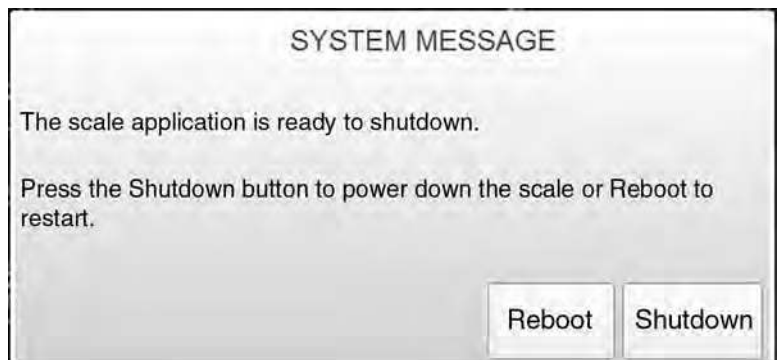

NOTICE

Do not remove power from the system by unplugging it. Always use the on/off switch on the back of the printer to power down the system. Failure to comply with will result in a service call.

6. Wait for the scale system to shutdown (the screen will go black).
7. Remove power by using the on/off switch on the back of the printer.

NOTE: The NGW Wrapping System is equipped with an automatic sleep/start feature. When all packages clear the machine it will only continue to run for a specified period of time. The machine shuts off, but the green light remains on. When you place a package on the intake, the machine automatically re-starts. The PLU remains the same.

8. Lift small access door on the right-hand side of the lower front panel of the wrapper and switch the main power switch off.

Logging onto the System

The NGW System may require an operator to login before printing a label. Not all systems are set up to require an operator to login.

NOTE: The Operator Login Screen can be configured to show a popup keypad or a full keyboard.

If required to login: TYPE the Operator ID and TOUCH OK.



Center Operator Screen

The Center Operator Screen displays product information for the PLU that is entered. The type of data displayed depends upon the product weigh type of the PLU.

The Center Operator Screen displays the following information, if applicable:

1. Weight (or will display By Count if PLU is sold by count)
2. Tare
3. Unit Price
4. Total Price
5. PLU Number
6. Description
7. Sell by date
8. Country of Origin Label (COOL) Text & Tracking Number (optional)
9. Best before date (optional)
10. Packed on date (optional)
11. Operation Mode

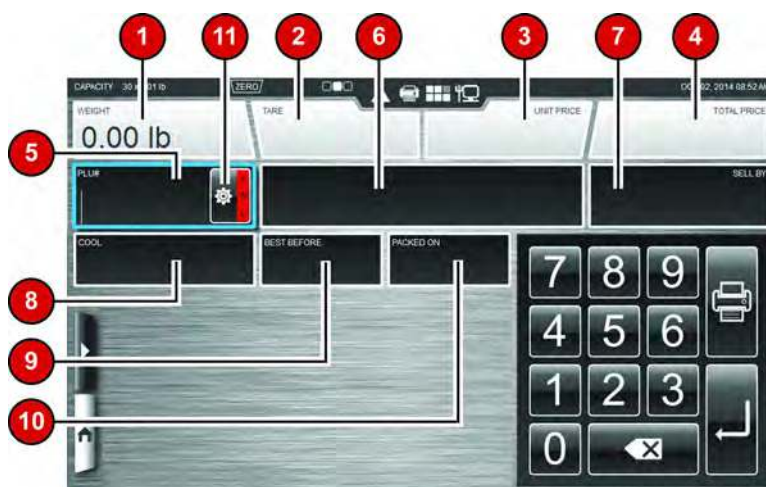

NOTE: System configuration may show different options.

Right Operator Screen

The Right Operator Screen displays wrapper settings, label placement, or product and label information for the PLU that is entered. The type of data displayed depends upon the data loaded for the PLU. See [Modifying the Wrapper Settings](#) or [Modifying the Label Placement](#) for information displayed on those screens.

The Right Operator Screen displays the following information, if applicable:

1. UPC Number
2. Discount Unit Price
3. Discount Total Price
4. Savings
5. Shelf Life (Hours)
6. Product Life (Hours)
7. Label Stock
8. Primary Label ID
9. Primary Graphic ID
10. Additional Label IDs
11. Additional Graphic IDs
12. Nutrition Facts Panel
13. Expanded Text
14. Recipe
15. Cooking Instructions
16. Allergens

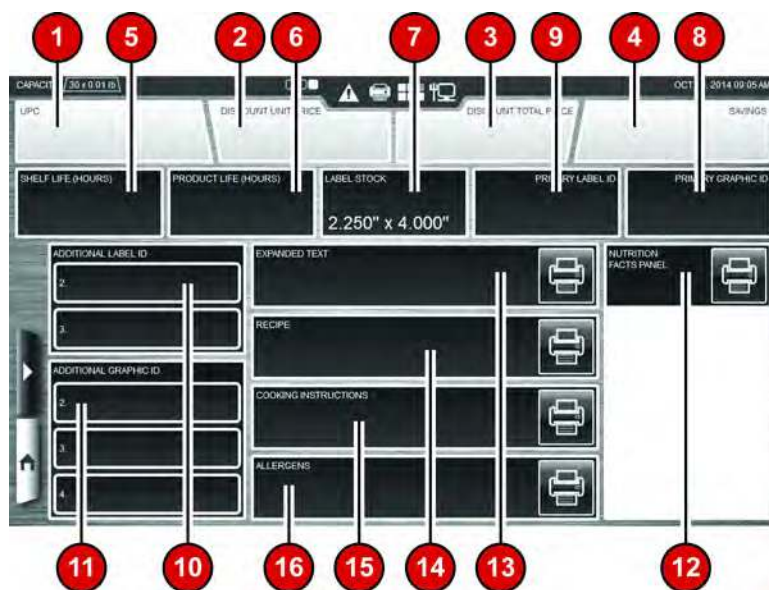

NOTE: System configuration may show different options.

Modifying the Operator Screens

The operator can modify certain settings that display on the Operator Screens once a PLU is entered. Only text fields with a green highlight around the box can be modified. Text fields with a blue highlight indicate the field is active and input from the keypad will modify the contents of the field. Text fields with a white border cannot be edited and provide information only.

NOTE: Changes made on the Operator Screens, other than certain COOL information, will be in effect for the current run only. The system will revert to the system default settings when a different PLU is entered.



To change Field values: TOUCH the field and TYPE the change on the Keypad. TOUCH Enter. The value change will be displayed in the field. This applies to Unit Price, PLU#, and By Count on the Center Operator Screen. This applies to Shelf Life (Hours), Product Life (Hours), Primary Label, and Additional Labels IDs on the Right Operator Screen.

To change Tare field: TOUCH the Tare field. TYPE the tare on the keypad or TOUCH the desired value from the tare grid as shown.



NOTE: The Tare Grid, shown above in the dynamic content area, is a feature that can be configured by the supervisor or operator. To change COOL: TOUCH the COOL field. You should now see the *COOL Window*.



NOTE: See Using Create COOL for information about modifying COOL. The setting changes made will be displayed on the Operator Screens.

SELECT the COOL text from the list available. TOUCH Done.

NOTE: “No COOL Text” means Do Not Print COOL on the label.

NOTE: These fields can only be changed in Operate Mode if you have the proper allowances.

To change the Sell By date or Best Before date: TOUCH the Sell By or Best Before field to activate. You should now see the Calendar Window.





The current date will display in blue. Use the arrows next to the month to change to the next or prior month. Select the date OR TYPE the number of days on the Keypad. The maximum is 998 days. If you do not want this information to appear on the label, TOUCH the Do Not Print circle. A black dot will appear in the circle when selected.

NOTE: Adding days to the Sell By field will automatically add days to the Best Before field in proportion to the days configured for that PLU.

NOTE: This screen is used to temporarily change the product and shelf life fields that will be printed on the label. It may be used to select which fields not to print on the label. These changes are temporary and will be lost when a new product is selected.

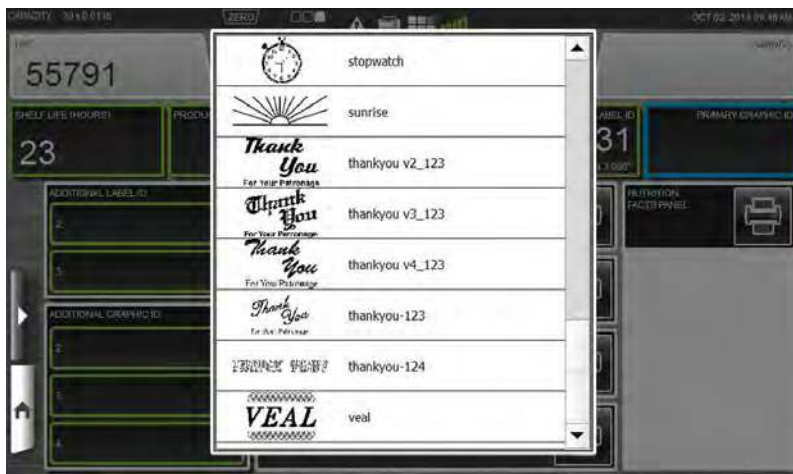
To change or add a graphic to the label: TOUCH the Primary Graphic ID and SELECT a graphic from the list or SELECT None from the list to remove the graphic. For additional graphics, use the same process for the Additional Graphic ID fields.





To print additional label information: Additional information, such as Expanded Text, Recipes, Allergens, Nutrition Facts Panel, and Cooking Instructions can be printed on separate labels. TOUCH the printer icon  next to the field to be printed.



NOTE: Changing or adding a graphic to the Label and printing additional label information can be located on Screen 3 of the scale.

NOTE: Nutrition Facts Panel includes high level information. Additional information may be included on the label.

Using the Search Function

From any screen, TOUCH the Menu Icon  . TOUCH the Search Icon  .



You should now see the **Search Window**. A search can be performed by a product number or by a product description.



To perform a Search by PLU: TOUCH the PLU Search check box. TYPE the PLU number using the keyboard.

To perform a Search by Description: TYPE the letters or numbers on the keyboard describing the product. As you enter characters the search will begin automatically.

TOUCH the scroll bar arrows to the right of the box containing the product list to scroll up or down and view all of the products listed.

SELECT the desired product on the list. The **Operator Screen** for the selected product will be displayed.

To exit this window: TOUCH anywhere outside of the keyboard or Search Window.

Help

This scale has an Operator Manual loaded on the scale.

To access the Operator Manual: TOUCH the Menu Icon .

TOUCH the Help Icon .



You should now see the Operator Manual and the Multimedia icon



will appear on the Home button. Multimedia files are items such as videos or manuals.

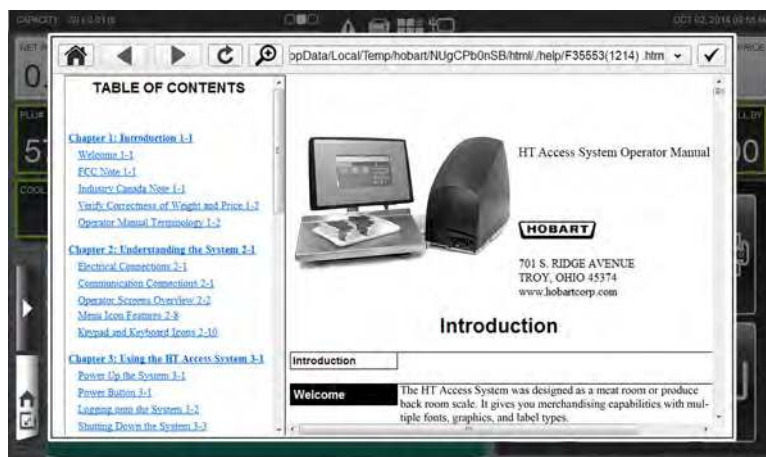

To minimize: TOUCH the Home button. The Multimedia icon should stay on the Home button.

To exit this window: TOUCH the check mark in upper right corner or anywhere outside of the window.

Operation Mode

The NGW Wrapping System can be configured to be used in different ways according to the needs of your operation. The Operation Mode feature will allow the system to be set up to operate in manual or automatic mode.

NOTE: There are different automatic modes available for use with the NGW Wrapping System.

TOUCH the Operation Mode area.



You should now see the Operation Mode Setup Screen.



To set the system to automatically wrap the product and print and apply a label: TOUCH the Apply, Wrap, and Label buttons until the buttons are green. TOUCH anywhere outside the Operation Mode Setup Screen to exit.

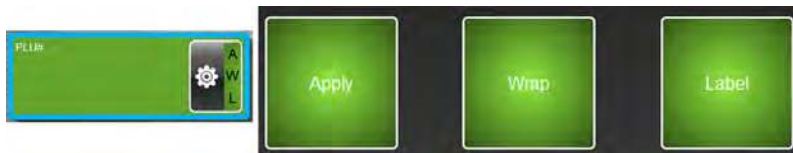

The A, W, & L in the Operation Mode area will change to green and the PLU# area will be green. A product is placed on the wrapper scale. The product will run through the wrapper and will be wrapped. A label will be printed when a stable weight has been sensed by the scale. The label will be applied to the product as the product emerges from the wrapper.

To set the system to automatically print a label: TOUCH the Label button until the button is green. TOUCH the Apply and Wrap buttons until the buttons are red. TOUCH anywhere outside the Operation Mode Setup Screen to exit.

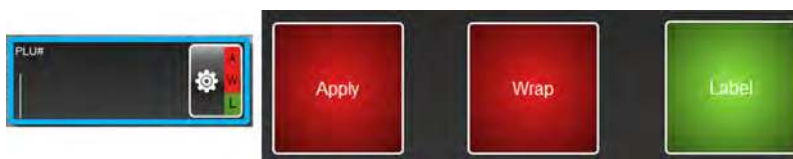

The L in the Operation Mode area will change to green and the PLU# area will be black. Place the product on the wrapper scale. A label will print automatically when a stable weight has been sensed by the scale. The label will not be applied to the product. Manually remove the label from the printer and apply to the product.

To set the system to automatically print and apply label (No Wrap): TOUCH the Apply and Label buttons until the buttons are green. TOUCH the Wrap button until the button is red. TOUCH anywhere outside the Operation Mode Setup Screen to exit.

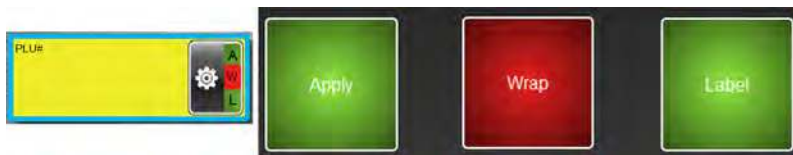

The A & L in the Operation Mode area will change to green and the PLU# area will be yellow. Place the prepackaged product on the wrapper scale. A label will print automatically when a stable weight has been sensed by the scale. The product will travel through the wrapper and the label will be applied. The product will not be wrapped.

To set the system to automatically wrap only: TOUCH the Wrap button until the button is green. TOUCH the Apply and Label buttons until the buttons are red. TOUCH anywhere outside the Operation Mode Setup Screen to exit.



The W in the Operation Mode area will change to green and the PLU# area will be black. A product is placed on the wrapper scale. The product will run through the wrapper and will be wrapped.

To set the system to manual mode: TOUCH the Apply, Wrap, and Label buttons until the buttons are red. TOUCH anywhere outside the Operation Mode Setup Screen to exit.



The A, W, & L in the Operation Mode area will change to red and the PLU# area will be black. A product is placed on the wrapper scale. TOUCH Print to print a label.

Running a Product

Running a product is the basic function of the operator. This function allows the operator to enter the PLU, weigh, wrap, print, and apply the label.

NOTE: If the PLU number is not known, use the search feature to find the desired product. See [Using the Search Function](#) for more information.

NOTE: The PLU# is the default field for the keypad.

From the *Operator Screen*, TOUCH a Flashkey –OR– TYPE the product number on the Numeric Keypad. You may need to TOUCH enter  to populate the Screen. You should now see the product information on the Operator Screen.

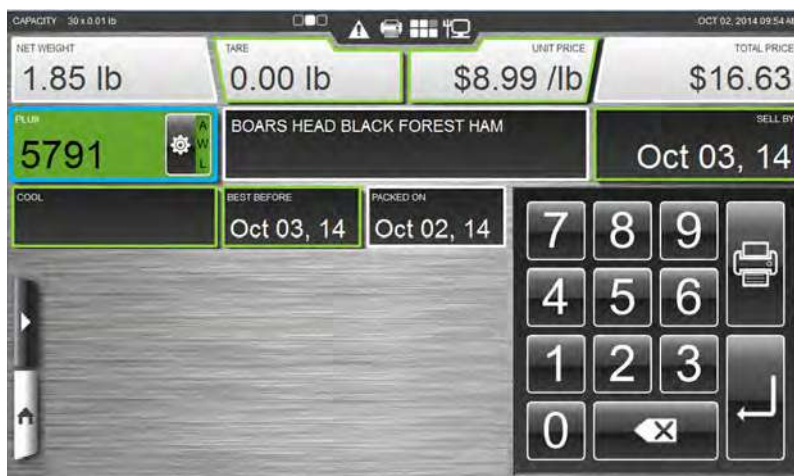

To run in Manual mode: Place the product on the scale. TOUCH the Print Icon  to print the label.

To run in Automatic mode: Select the automatic setting for this run. See [Operation Mode](#). Place the product on the wrapper scale. The automatic functions will begin when a stable weight has been sensed by the scale.

Some PLU's may require information to be entered before the run can start or the print icon can be used. This is called a forced field. It can be identified by the red field with a blue highlight. Enter the required information. The example shown requires the Unit Price to be entered before the product label can be printed.



Using Create COOL

From any screen, TOUCH the Menu Icon  . TOUCH Create COOL. You should now see the *Create COOL Window*.



To create COOL text: SELECT the appropriate production step from those listed in the Production Steps box. Repeat this procedure to SELECT the country from the list in the Countries box in which the production step was performed. The production step and country selected will be displayed in the COOL Text name box. TOUCH the Add To Shortlist button to create this COOL option. If needed, TOUCH the Clear button to delete the COOL text.

To exit this window: TOUCH anywhere outside of the Create COOL Window or the Operator Pages box. TOUCHING the Home button will result in losing the current PLU information.

Modifying the Printer Settings

From any screen, TOUCH the Menu Icon  . TOUCH Printer Settings.



You should now see the *Printer Settings Window*.

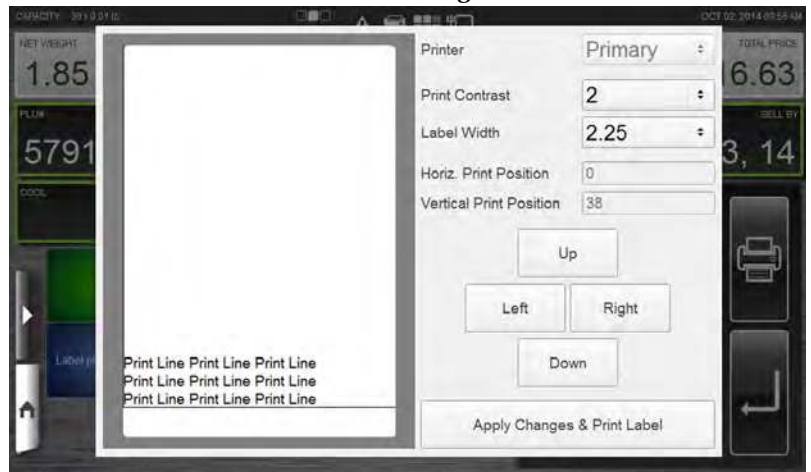

To change the Printer Type: TOUCH the Printer field and SELECT Primary, Second, Third, or None.

To change the Print Contrast: TOUCH the Print Contrast field and SELECT a number from 0-7. TOUCH the Apply Changes & Print Label button to save changes and print a sample label.

NOTE: Use the lowest contrast level that produces acceptable print to preserve print head life. A value of 0 is the lightest and 7 is the darkest.

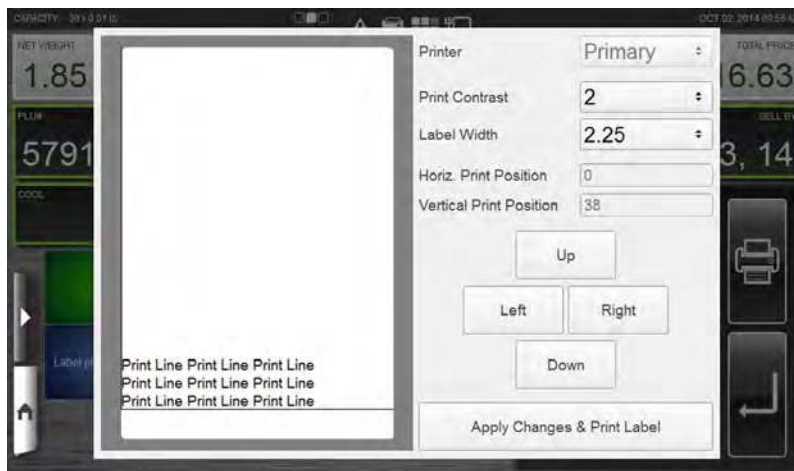

To change the Horizontal Print Position: TOUCH the Left or Right buttons to move the print to the left or the right on the label. TOUCH the Apply Changes & Print Label button to save changes and print a sample label.

To change the Vertical Print Position: TOUCH the Up or Down buttons to move the print up or down on the label. TOUCH the Apply Changes & Print Label button to save changes and print a sample label.

NOTE: Increasing the vertical print value will move the print up on the label and expel the label farther out of the printer. Lowering the vertical print value will lower the print on the label and will not expel as far out of the printer. If this value is too low, the labels may hang up in the printer preventing the label from being picked by the label applier.

To exit this window: TOUCH anywhere outside the Printer Settings Window. All changes made will be saved when the window is exited.

Selecting Total Types

From any screen, TOUCH the Menu Icon  . TOUCH Total Types. You should now see the *Total Types Window*.



To select a Total Type: TOUCH the Total Type field and SELECT a Total Type.

To exit this window: TOUCH anywhere outside the Total Types Window.

Voiding a Transaction

From any screen, TOUCH the Menu Icon  . TOUCH Void Transaction. You should now see the *Void Transaction Window*.



To Void a Transaction: TOUCH the Transaction to highlight it (multiple transactions can be selected if desired) and TOUCH the Void button. ALL the highlighted transactions will be voided. There will be no further indication on the screen that the transaction has been completed. Void does not remove the item from the database.

To exit this window: TOUCH anywhere outside the Void Transaction Window.

Rezero the Weigher

Ensure that nothing is on the scale platter. From any screen, TOUCH the Menu Icon  . TOUCH Rezero Weigher.



A message box will appear briefly; no other action is required.



If system message does not automatically dismiss, TOUCH OK to dismiss message.

Viewing Product Notes

If a product note is available, a Product Note message will appear when the PLU is entered.



To exit this window: TOUCH OK.

Ejecting Media

If a thumb drive or other USB device is inserted into an available USB port, use the Eject Media feature before removing from the system.

From any screen, TOUCH the Menu Icon . TOUCH Eject Media. You should now see the *Eject Media Window*.

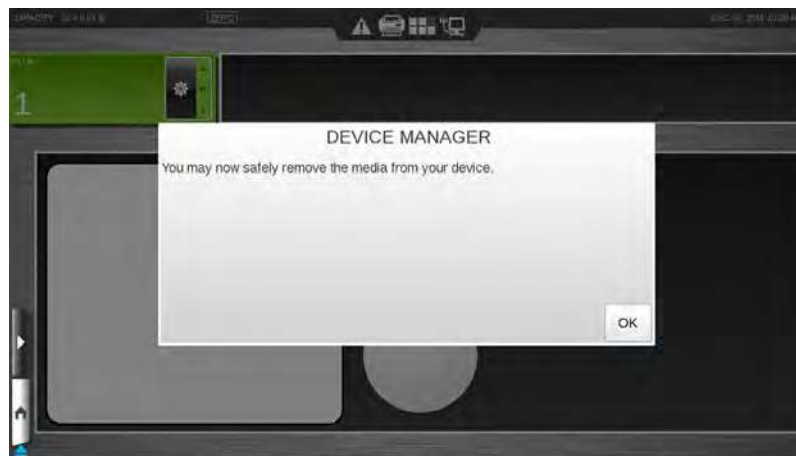

Remove the USB device.

To exit this window: TOUCH OK.

Viewing Operator Note

From any screen, TOUCH the Menu Icon . TOUCH Operator Note.



You should now see the *Operator Note Window*. This is only available if there is a note.



To exit this window: TOUCH OK.

Viewing Weights & Measures Information

From any screen, TOUCH the Menu Icon  . TOUCH Weights & Measures.



You should now see the *Weights & Measures Window*.

NOTE: The information on this screen will vary depending on the peripherals attached. An example screen is shown below.

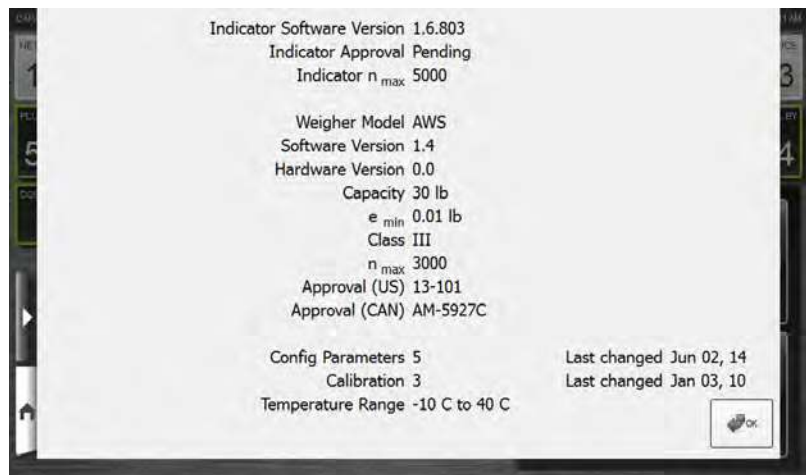

To exit this window: TOUCH OK.

Viewing About Scale Information

From any screen, TOUCH the Menu Icon  . TOUCH About Scale.



You should now see the *About Scale Window*.



TOUCH Features to view a list of currently installed features associated with this wrapper.

TOUCH Licensing to view a list of any optional license installed on this system.

To exit this window: TOUCH anywhere outside of the window.

Using the Flashkey Editor

The Flashkey Editor allows the operator to set up quick and easy access to various system functions and frequently used PLU's. The flashkeys will appear in the dynamic content area of the center operator screen. Additional flashkey features can be configured in supervisor mode.

From any screen, TOUCH the Menu Icon  . TOUCH Flashkey Editor.



You should now be on the *Flashkey Editor Screen*.

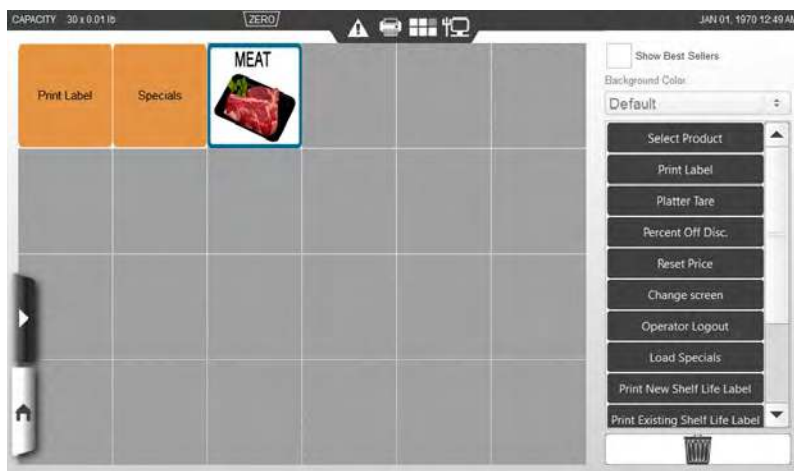

NOTE: TOUCHING a flashkey will cause a description of that flashkey to populate in the Function Description box.

To add a flashkey: SELECT a flashkey from the list on the right and drag the flashkey to the desired location on the grid. TOUCH the scroll bar arrows to the right of the box containing the flashkeys to scroll up or down and view all of the flashkeys listed.

To remove a flashkey: TOUCH, hold, and drag the flashkey to the trash can.

To change the background color: TOUCH Change Background Color on the upper right side of the screen. You should now see a list of background colors available.

To use the Best Sellers: TOUCH Use Best Sellers check box in the upper right of the screen. A check will appear in the check box when Best Sellers is activated. The system automatically determines the best-seller keys based on sales data from that individual wrapper.

NOTE: The background color for best-seller keys cannot be changed.

To exit the Flashkey Editor: TOUCH home icon.

Modifying the Wrapper Settings

From any screen, TOUCH the Menu Icon  . TOUCH Wrapper Settings.



You should now see the *Wrapper Settings Screen*.



NOTE: Depending on the configuration of the wrapper, there may be only one film width listed.

To change the Film Width: TOUCH the Film Selection field to force a particular roll of film to be used. This field is normally set to Automatic.

To load Film: SELECT the film width and TOUCH the Load button beside film width.

To cut the Film: TOUCH the Cut button beside film selection.

To turn on/off the Sealer Belt Power: TOUCH the Sealer Belt Power field and SELECT either On or Off.

To change the Belt Temperature: TOUCH the Belt Temperature Setting field. The Numeric Keypad will be displayed. TYPE the Belt Temperature Setting on the Numeric Keypad. TOUCH Enter.

To change the Intake Mode: TOUCH the Intake Mode field and bring up the Intake Mode drop-down selections, either Normal or Gentle. Gentle will convey the package at a lower speed. Gentle should be used for frozen or unstable products.

To change Film Tension: TOUCH the Film Tension field and SELECT either High, Medium, or Low. TOUCH the Tension Front to Back field and SELECT number to increase or decrease tension. TOUCH the Tension Left to Right field and SELECT number to increase or decrease tension. Normal tension setting is medium.

To exit the Wrapper Settings: TOUCH home icon.

Modifying the Label Placement

From any screen, TOUCH the Menu Icon  . TOUCH Label Placement.



You should now see the *Label Placement Screen*.



To change the Printer Selected: TOUCH the Printer field. The printer drop-down selections of Primary and Secondary will be displayed. SELECT the printer. The default settings for the selected printer will be displayed.

NOTE: If only a Primary printer is available, the Primary printer text box will be disabled.

To change the Label Apply Position: TOUCH the Label Position and SELECT Right or Left.

To change the Label Rotation: TOUCH the Label Rotation dial until the label shown on the screen is in the desired orientation. The following chart shows the options available.

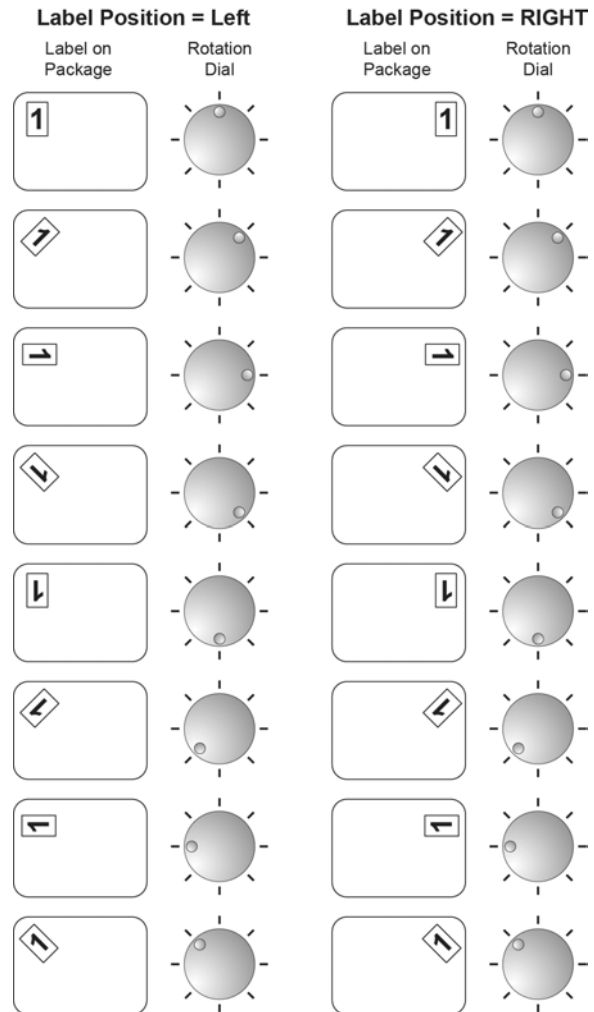

To exit the Label Placement screen: TOUCH home icon.

Chapter 4: Maintenance & Cleaning

Cleaning and Maintaining your System

This durable NGW Wrapping System has been designed and manufactured to resist corrosion, scratches, stains, alkaline, protein and food acid when cared for properly. Improper care can permanently damage the wrapper, electronics and printer.

Proper cleaning prolongs the life and productivity of the machine. This machine should be thoroughly cleaned on a daily basis (more often, if necessary). If the system is not cleaned on a regular basis it may not run consistently and will cause service problems. Failure to follow use, care and maintenance as noted may void your Hobart warranty.

About Proper Care

The following information was derived from the brochure - STAINLESS STEEL EQUIPMENT CARE AND CLEANING (F-24845) distributed by NAFEM.

Corrosion of metals is everywhere. We recognize it on iron and steel as rust. These are called **active metals** because they actively corrode in the natural environment. Stainless steels are **passive metals** because they contain other metals, like chromium and nickel.

There are three basic components which can break down your stainless steel's passivity layer (micro-thin film) and allow corrosion:

Enemies of Stainless Steel

Component	Explanation
Mechanical Abrasions	Items that will scratch the steel's surface. Steel pads, wire brushes, and scrapers are prime examples.
Deposits and Water	Water comes out of the tap in varying degrees of hardness. Depending on what part of the country you live in, you may have hard or soft water. Hard water may leave spots. Also, when heated, hard water leaves deposits behind that, if left to sit, will break down the passive layer and rust your stainless steel. Other deposits from food preparation and service must be properly removed.
Chlorides	Chlorides are found nearly everywhere. They are in water, food, and table salt. One of the worst perpetrators of chlorides can come from household and industrial cleaners.

Steps to help prevent stainless steel from rusting or pitting:

1. **Use the proper tools.** Soft cloths and plastic scouring pads will not harm the stainless steel's passive layer.
2. **Clean with the polish lines.**
3. **Use alkaline, alkaline chlorinated or non-chloride containing cleaners.** Also, avoid cleaners containing quaternary salts as they can attack stainless steel and cause pitting and rusting.
4. **Treat your water.** If you are not sure of the proper water treatment, call a treatment specialist.
5. **Keep your food equipment clean.** Clean frequently to avoid buildup of hard stubborn stains.
6. **Rinse, Rinse, Rinse.** If chlorinated cleaners are used you must rinse and wipe dry immediately. The sooner you wipe off standing water, especially when it contains cleaning agents, the better. After wiping the equipment down, allow it to air dry for the oxygen helps maintain the stainless steels' passivity film.
7. **Never use hydrochloric acid on stainless steel.**

Guidelines

All food-contact surfaces must be washed, rinsed, and sanitized:

- after each use
- when you begin working with another type of food
- anytime you are interrupted during a task
- at four hour intervals, if the items are in constant use

Other components should be cleaned and sanitized at least once each day and whenever they become soiled.

⚠ WARNING

Before using cleaning solvent, all food products and packaging materials must be removed from the area or carefully protected. All odor of the cleaner must dissipate before food products or packaging materials are exposed. Refer to manufacturers instructions.

NOTICE FDA Code of Regulations Vol. 21 require solutions containing chlorine to be of no greater concentration than 200 ppm. Solutions containing concentrations greater than 200 ppm chlorine will accelerate corrosion of metals.

NOTICE Proper cleaning solvent is available from your local Hobart service office for all rubber surfaces. Observe the instructions on the bottle.

Cleaning/Rinsing Guidelines

Refer to the following Cleaning and Rinsing guidelines.

Do	Don't
<p><u>DO</u> use products formulated to be safe on stainless steel (mild soap and water are recommended).</p>	<p><u>DON'T</u> dampen labels, electronic parts, or connections.</p> <p><u>DON'T</u> use steam or a high pressure water spray to clean the system.</p> <p><u>DON'T</u> operate and/or store the system in an environment with relative humidity levels consistently in excess of 70%.</p> <p><u>DON'T</u> use:</p> <ul style="list-style-type: none"> • Chloride-Based cleaners • Formula 409 • Glass Cleaners (i.e. Scotty's Glass Cleaner) • Citrus-Based Cleaners (i.e. Citro-Sol or Bio-T) • Caustic Cleaners with high pH (i.e. Butchers Block, concentrated Lysol or Pinesol) <p><u>DON'T</u> exceed chemical manufacturer's recommended concentrations for detergent.</p>

Sanitizing Guidelines

Do				Don't
<u>DO</u> use 5% Chlorine Bleach (5.25% Sodium Hypochlorite).				<u>DON'T</u> exceed chemical manufacturer's recommended concentrations for sanitizer.
<u>Ratio</u>	<u>Bleach</u>	<u>Water</u>	<u>Concentration</u>	<u>DON'T</u> use solutions of greater than 200 ppm concentration of chlorine cleaners.
1 : 250	1 tsp.	1 gal.	200 ppm	
1 : 500	1/2 tsp.	1 gal.	100 ppm	
1 : 1000	1/4 tsp.	1 gal.	50 ppm	
1 : 2000	1/8 tsp.	1 gal.	25 ppm	

Cleaning Instructions

Prior to cleaning, power down the touch screen, printer and wrapper. See *Shutting Down the System*. Unthread the film from the film selector.

⚠ WARNING

Disconnect power source to wrapper before cleaning.

⚠ WARNING

Cover the printer and console with the provided covers before hosing down the wrapper.

NOTICE

Use of high pressure washing system will cause damage to the wrapper.

Cleaning Each Component

To appropriately clean each component of the system, refer to the following component cleaning table.

Component Cleaning Table



NOTE: Optional heater shown.

Component	Explanation
Rear Film Chamber	Clean as needed with a soft cloth moistened with a mild detergent and water. Rinse and allow to air dry.

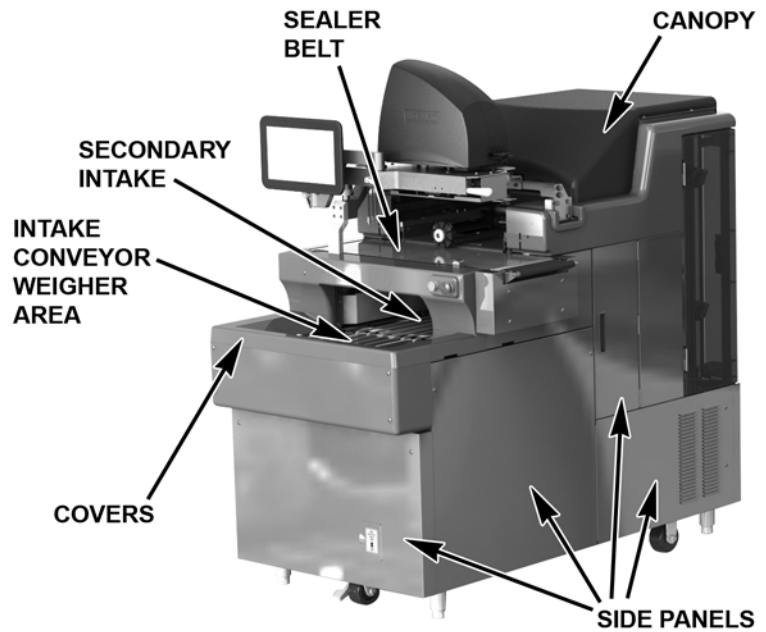

Component	Explanation
Canopy and Film Chamber Doors	Clean as needed with a soft cloth moistened with a mild detergent and water. Rinse and allow to air dry.
Covers (External - Plastic)	Clean as needed by using a soft cloth moistened with a mild detergent and water. Rinse and allow to air dry.
Sealer Belt	<p>⚠ WARNING Hot surface. Do not touch.</p>
	Clean as needed by using a soft cloth moistened with a mild detergent and water. Rinse and allow to air dry.
Side Panels (Stainless Steel)	Clean as needed by using a soft cloth moistened with a mild detergent and water. Rinse and allow to air dry.



Component	Explanation
Intake Conveyor Area and Weigher Rods	Clean as needed by using a long-handled brush or a moist cloth. Weigher rod plates and intake pan can be removed and cleaned in a sink with mild detergent and water. Note the location of the locating tab on the intake pan. Use a long-handled brush for additional cleaning of the belts. Replace weigher rod plates and intake pan after cleaning. Rinse and allow to air dry. Replace weigher rod plates before power up or weigher will come up outside maintenance zone.

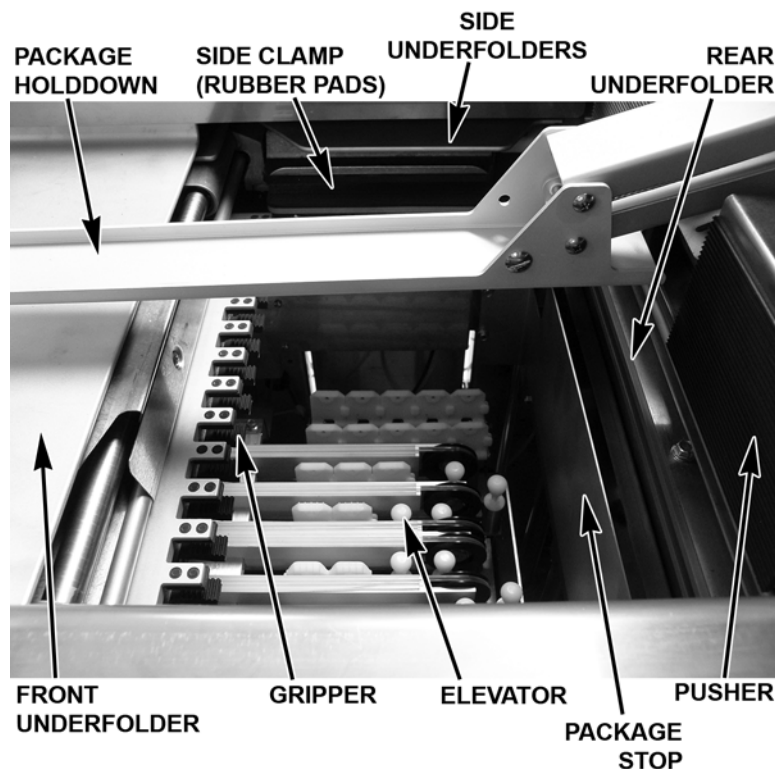

Component	Explanation
Package Hold Down	Lift upward and clean as needed with a soft cloth moistened with a mild detergent and water. Rinse and allow to air dry.
Rubber Pads, Side Clamp Gripper	Clean as needed with Hobart cleaning solvent or isopropyl alcohol.
Rubber Roller (in film selector)	Clean as needed with Hobart cleaning solvent or isopropyl alcohol.
Front, Rear and Side Underfolders	Clean as needed by using a soft cloth moistened with a mild detergent and water. Rinse and allow to air dry.
Elevator Area	Clean as needed by using a soft cloth. Open the canopy and the side doors to get access to the elevator area. Rinse and allow to air dry. A soft brush may be required to reach confined areas.

Once cleaning is complete and any steam in the room has dissipated, restore power to the printer and wrapper. See [Power Up the System](#).

NOTICE Before restoring power, insure there is no water remaining on the weigher. This could result in the system coming up out of zero range.

Removing Labels

To remove labels from the printer:

1. Open the printer label access door.
2. Pull the printhead positioning lever toward the printhead to lower the printhead.

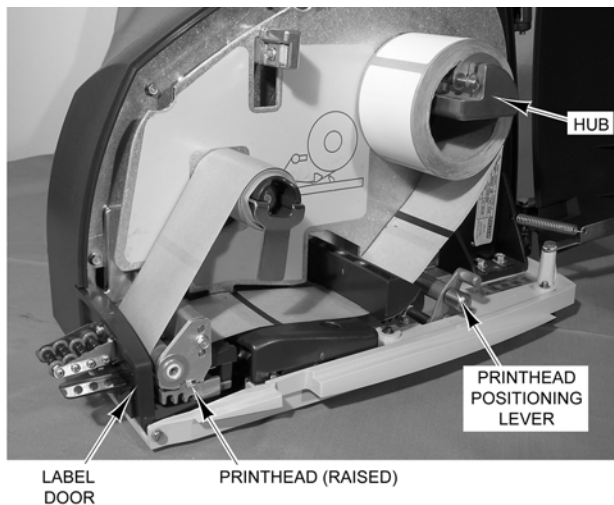

3. Pull on the label door to lower the label door.

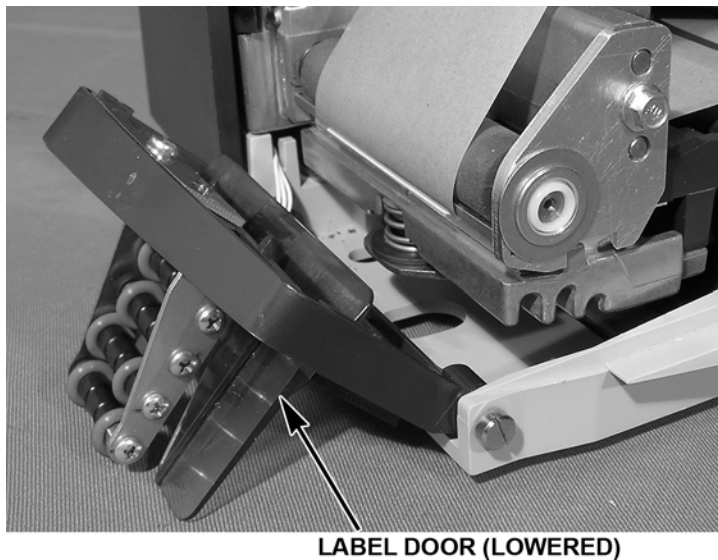

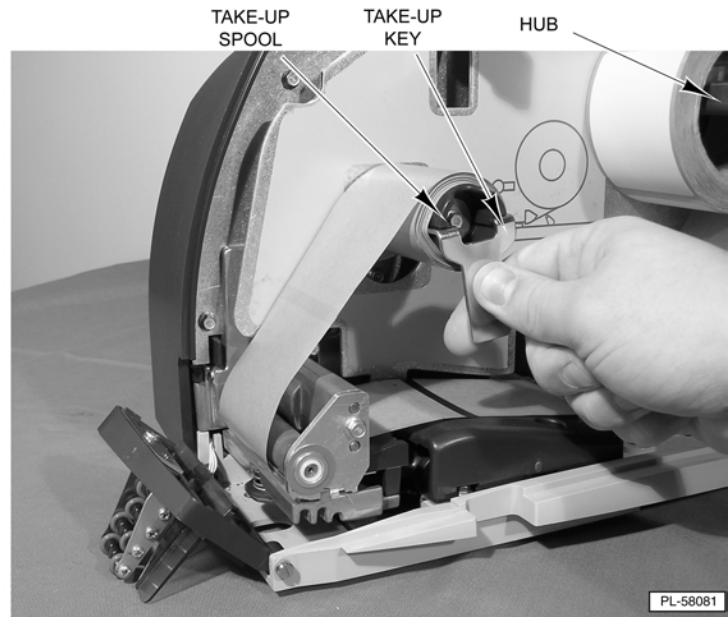

4. Remove the take-up spool key.
5. Remove the label backing paper from the take-up spool and the label roll from the hub.

Loading Labels

NOTE: Before loading labels:

- See [Cleaning the Printhead](#) to clean the printhead and roller.
- See [Setting the Label Size Plate](#).

To load labels in the printer:

1. Remove labels from the first 12 inches of the new label roll. This will create a leader to attach to the take-up spool.
2. Pull the printhead positioning lever toward the printhead to lower the printhead.

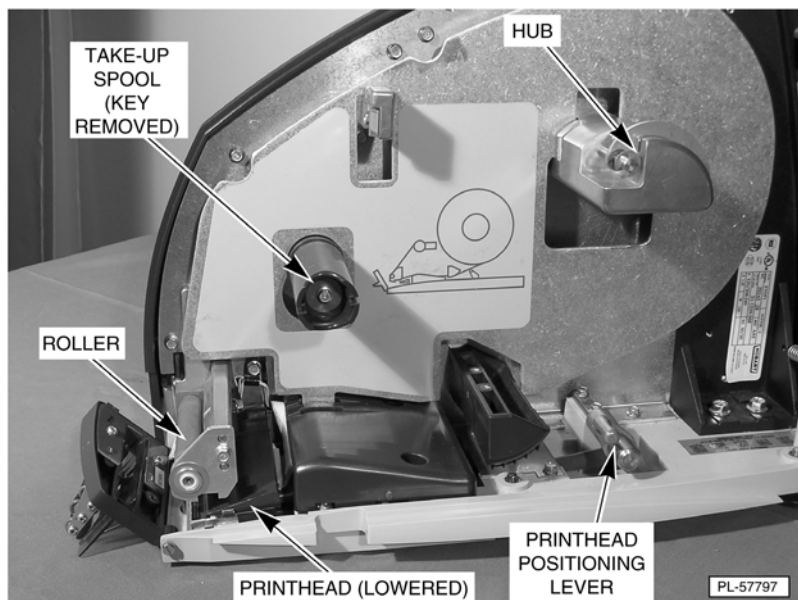

3. Pull on the label door to lower the label door.

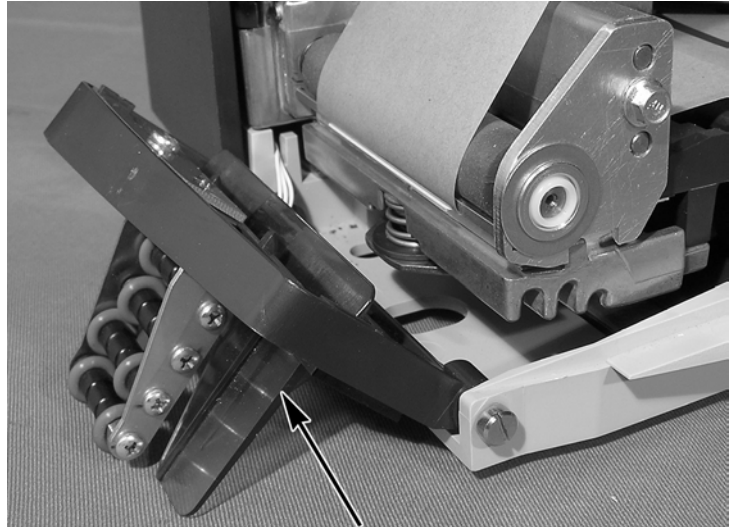

LABEL DOOR (LOWERED)

4. Place the label roll on the hub. The leader feeds from the bottom of the roll in a clockwise direction.
5. Remove the take-up spool key.

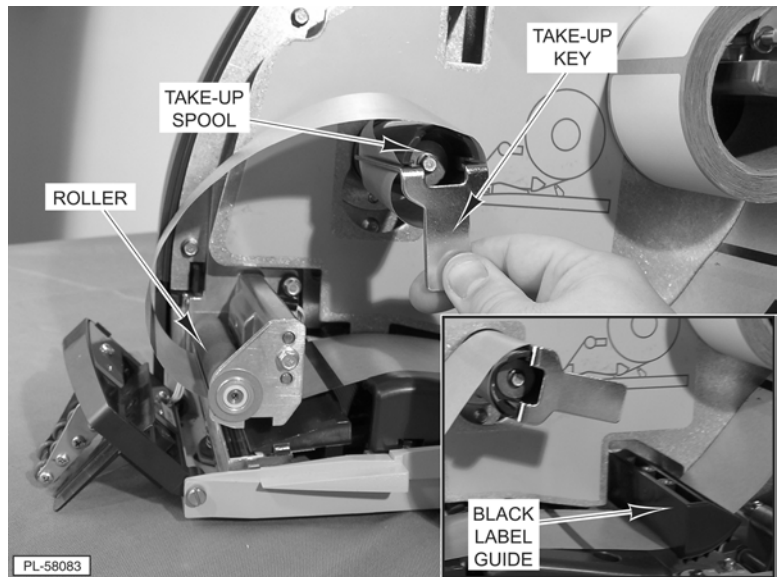

6. Wrap the leader under the black label guide, around the roller and the take-up spool, and insert the take-up spool key. Insert the short side of the key first and catch the leader under the long side of the key.
7. Take up the leader slack and align the leader on the spool.

8. Close the label door on the front of the printer.

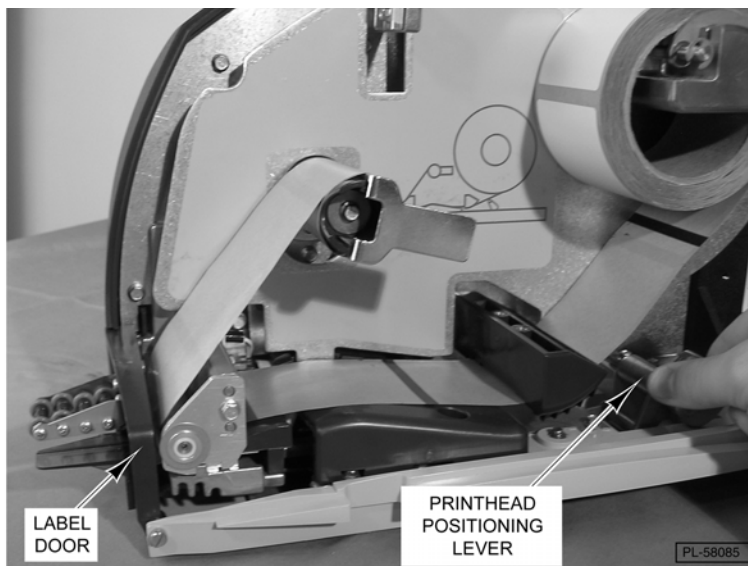

9. Pull the printhead positioning lever away from the printhead to raise the printhead into position. The printer will automatically advance the labels through the printhead setting the labels in the ready position.
10. Close the printer label access door.

Setting the Label Size Plate

To set the label size plate:

1. Lift the label plate and set it in the slots for the size labels being used.
2. Move the lever on the hub to the slot for the size labels being used.

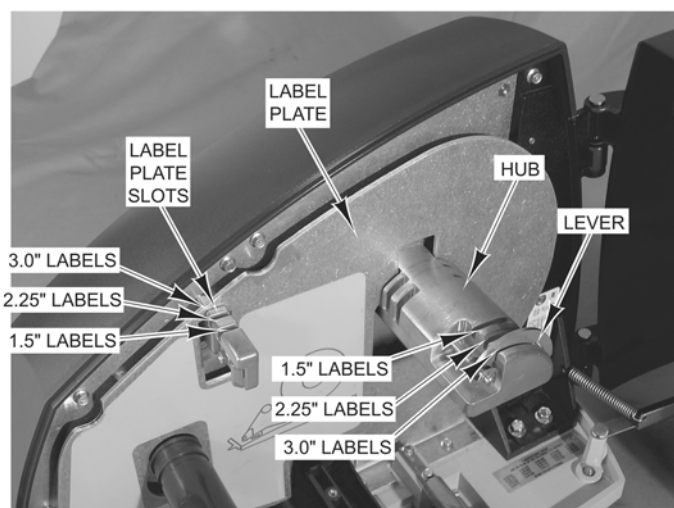

NOTE: If you change the label size, make sure to adjust the printer settings (see [Modifying the Printer Settings](#)).

Cleaning the Printhead

The printhead of your Printer should be cleaned approximately once each week, or whenever labels are obstructed due to a residue buildup on the printhead and/or roller. It is a good idea to clean the printhead roller whenever a new roll of labels is installed. To obtain a Printhead Cleaning Kit, contact your local Hobart Representative; request Part Number 00-913096-00001. Due to shipping restrictions, the 70% Isopropyl Alcohol must now be purchased locally.

NOTICE

Do not use a metal tool on the printhead. This could scratch or break the printhead. In addition, monitor the printer to look for labels stuck on the printer parts. If found, remove these labels at once following the instructions given below. Cleaning of the Printer Unit is a customer responsibility and will not be covered by Hobart Warranty.

To clean the printhead:

1. With the label door lowered, the labels removed, and the printhead in the lowered position, check to see if the printhead is clean and free of label stock and label adhesive.

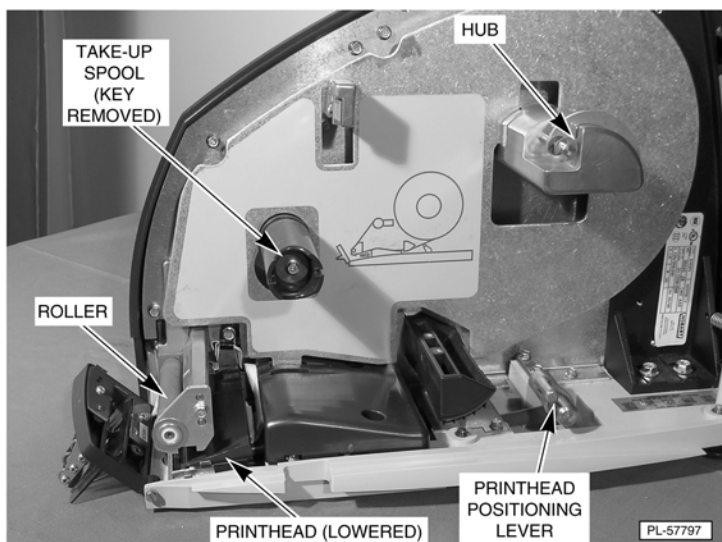

2. Use the scraper from the Printhead Cleaning Kit to remove stuck-on label stock.
3. To remove burnt-on adhesive, gently rub the printhead surface with the eraser from the Printhead Cleaning Kit.
4. Using the cleaner and a swab from the Printhead Cleaning Kit, scrub the printhead until all of the residue is removed.
5. Clean the roller with the cleaner and swabs.
6. Allow the printhead and roller to dry before loading labels.

Chapter 5: Troubleshooting

Troubleshooting

In the event that your NGW Wrapping System does not operate as expected, please read through the following troubleshooting section before calling for service. Ensure film is loaded correctly and film selector is locked. Verify film roll is tightened on film arbor and all rubber pads and rollers are clean.

Tip

Properly loaded trays produce the most attractively wrapped packages and can enhance wrapper operation by reducing re-wraps, product spillage and loss, repeated shutdowns, machine damage, etc.

To insure proper loading:

- ◆ Keep all product in the tray.
- ◆ Avoid top-heavy packages to prevent product from rolling out.
- ◆ Avoid stacking product whenever possible.
- ◆ Use appropriate sized tray.
- ◆ Keep loose product flat in the tray.

An improperly loaded tray has the following attributes:

- ◆ Product exceeds height requirement and is unstable. You should hand wrap oversized items to avoid possible machine damage.
- ◆ Product is unstable or overhanging tray. Use larger and deeper tray or hand wrap.

These guidelines can improve product appearance, case life, and overall productivity.

NOTICE

If the machine has shutdown because of an error, correct the problem, cycle the stop switch, and push the START button. The error message displays again if the error is not corrected.

Follow the intuitive operator diagnostics shown on the console.

NOTE: The following is an example of the intuitive operator diagnostics shown on the console. See [Reviewing System Errors](#) for a list of all possible messages.

When an error occurs: The error message will appear on the display.



TOUCH OK.

Follow the directions on the display. The pictures shown will help direct you to the correct location to resolve the issue.



TOUCH Dismiss to return to the Home page.

NOTE: The error will continue to display until the issue is resolved. In some cases, multiple errors may need to be resolved in order to clear the system error. Follow all instructions as shown on the display. If the issue is not resolved, see [Possible System Problems](#).

Reviewing System Errors

The following system error messages display at the console, if problems occur.

Error #	Message	What should I do?
9501	The wrapper stopped communicating.	Check to be sure the wrapper cable is plugged in. Press the STOP button, then press the START button to home the machine.
9502	Primary intake sensor or belt failure.	Remove any packages, labels, debris in the machine. Press the START button. If problem persists please call service.
9503	Primary intake motor failure.	Remove any packages, labels, debris in the machine. Press the START button. If problem persists please call service.
9505	Secondary intake motor failure.	Remove any packages, labels, debris in the machine. Press the START button. If problem persists please call service.
9506	Height sensor calibration failure.	Turn off circuit breaker, clean camera's, light tube and height sensors. Remove any packages, labels, debris in the machine. Turn on circuit breaker when complete
9507	Rear Folder belt or sensor failure.	Remove any packages, labels, debris in the machine. Press the START button. If problem persists please call service.
9508	Rear Folder motor electrical failure.	Remove any packages, labels, debris in the machine. Press the START button. If problem persists please call service.
9510	Front Folder belt or sensor failure.	Remove any packages, labels, debris in the machine. Press the START button. If problem persists please call service.
9511	Front Folder motor electrical failure.	Remove any packages, labels, debris in the machine. Press the START button. If problem persists please call service.
9512	Sealer Belt motor electrical failure.	Remove any packages, labels, debris in the machine. Press the START button. If problem persists please call service.
9513	Pusher sensor or belt failure.	Remove any packages, labels, debris in the machine. Press the START button. If problem persists please call service.
9514	Pusher motor electrical failure.	Remove any packages, labels, debris in the machine. Press the START button. If problem persists please call service.

Error #	Message	What should I do?
9515	Primary conveyor not at home.	Press the START button to home the machine.
9516	Camera and height sensors blocked.	Turn off circuit breaker, clean cameras, light tube and height sensors. Clean overhead camera lenses. Remove any packages, labels, debris in the machine. Turn on circuit breaker when complete.
9517	Primary intake jammed	Remove any packages, labels, debris in the machine. Press the START button.
9518	Primary conveyor did not find home.	Remove any packages, labels, debris in the machine. Press the START button.
9519	Intake blocked.	Remove any packages, labels, debris in the machine. Press the START button.
9520	Secondary timing error.	Remove any packages, labels, debris in the machine. Press the START button.
9521	Measurement Error.	Remove any packages, labels, debris in the machine. Press the START button.
9522	Intake sensor error.	Remove any packages, labels, debris in the machine. Press the START button.
9523	Secondary intake jammed.	Remove any packages, labels, debris in the machine. Press the START button.
9524	Centering conveyor not at home.	Press the START button to home the machine.
9525	Cameras need alignment.	Turn off circuit breaker, clean cameras, light tube and height sensors. Remove any packages, labels, debris in the machine. Turn on circuit breaker when complete.
9526	Package is too far left.	Remove any packages, labels, debris in the machine. Press the START button.
9527	Package is too far right.	Remove any packages, labels, debris in the machine. Press the START button.
9528	Centering conveyor did not find home.	Remove any packages, labels, debris in the machine. Press the START button.
9530	Elevator not at home.	Press the START button to home the machine.
9531	Elevator jammed.	Remove any packages, labels, debris in the machine. Press the START button.
9532	Elevator motor electrical failure.	Remove any packages, labels, debris in the machine. Press the START button. If problem persists please call service.

Error #	Message	What should I do?
9533	Elevator failed to home.	Remove any packages, labels, debris in the machine. Press the START button.
9534	Elevator sensor cam failure.	Remove any packages, labels, debris in the machine. Press the START button. If problem persists please call service.
9535	Elevator sensor is not working.	Remove any packages, labels, debris in the machine. Press the START button.
9537	Package will not wrap with selected film.	Check roll sizes in wrapper settings page. Remove any packages, labels, debris in the machine. Press the START button.
9538	Film not pulled.	Check to make sure film is properly loaded and the gripper and film selector are clear of debris. Press the START button.
9539	Gripper not at home.	Press the START button to home the machine.
9540	Knife Error.	Remove any packages, labels, debris in the machine. Press the START button.
9541	Gripper jammed.	Remove any packages, labels, debris in the machine. Press the START button.
9542	Gripper did not find home.	Remove any packages, labels, debris in the machine. Press the START button.
9543	Gripper sensor or belt failure.	Remove any packages, labels, debris in the machine. Press the START button. If problem persists please call service.
9544	Gripper motor electrical failure.	Remove any packages, labels, debris in the machine. Press the START button. If problem persists please call service.
9546	Side clamps not at home.	Press the START button to home the machine.
9547	Side clamps jammed.	Remove any packages, labels, debris in the machine. Press the START button.
9548	Side folders not at home.	Press the START button to home the machine.
9549	Side folders jammed.	Remove any packages, labels, debris in the machine. Press the START button.
9550	Rear folder not at home.	Press the START button to home the machine.
9551	Rear folder jammed.	Remove any packages, labels, debris in the machine. Press the START button.
9552	Front folder not at home.	Press the START button to home the machine.

Error #	Message	What should I do?
9553	Front folder jammed.	Remove any packages, labels, debris in the machine. Press the START button.
9554	Pusher not at home.	Press the START button to home the machine.
9555	Pusher jammed.	Remove any packages, labels, debris in the machine. Press the START button.
9556	Sealer belt jammed.	Remove any packages, labels, debris in the machine. Press the START button.
9557	Knife jammed.	Remove any packages, labels, debris in the machine. Press the START button.
9558	Label applier did not find home.	Remove any packages, labels, debris in the machine. Press the START button.
9559	Temperature Error.	
9560	Heater Error.	
9562	Side Clamp sensor or belt failure.	Remove any packages, labels, debris in the machine. Press the START button. If problem persists please call service.
9563	Side Clamp motor electrical failure.	Remove any packages, labels, debris in the machine. Press the START button. If problem persists please call service.
9565	Wrapper lost CAN communications.	Cycle the circuit breaker. Press the START button.
9567	Canopy open.	Please close the canopy. Remove any packages, labels, debris in the machine. Press the START button.
9568	Right-side access door open.	Please close the door. Remove any packages, labels, debris in the machine. Press the START button.
9569	Left-side access door open.	Please close the door. Remove any packages, labels, debris in the machine. Press the START button.
9570	Canopy open.	Please close the canopy. Remove any packages, labels, debris in the machine. Press the START button.
9571	Rear film door open.	Please be sure both film doors are closed. Remove any packages, labels, debris in the machine. Press the START button.

Error #	Message	What should I do?
9572	Rear film door open.	Please be sure both film doors are closed. Remove any packages, labels, debris in the machine. Press the START button.
9573	Side Folder sensor or belt failure.	Remove any packages, labels, debris in the machine. Press the START button. If problem persists please call service.
9574	Side Folder motor electrical failure.	Remove any packages, labels, debris in the machine. Press the START button. If problem persists please call service.
9575	Side clamps did not find home.	Remove any packages, labels, debris in the machine. Press the START button.
9576	Side folders did not find home.	Remove any packages, labels, debris in the machine. Press the START button.
9577	Rear folder did not find home.	Remove any packages, labels, debris in the machine. Press the START button.
9578	Front folder did not find home.	Press the STOP button. Remove any packages, labels, debris in the machine. Press the START button.
9579	Pusher did not find home.	Remove any packages, labels, debris in the machine. Press the START button.
9581	Package stopped on secondary intake.	Remove any packages, labels, debris in the machine. Press the START button.
9584	Package is too tall.	
9585	Node 1 motor fuse may be blown.	Cycle the circuit breaker. Press the START button. If problem persists please call service.
9586	Node 2 motor fuse may be blown.	Cycle the circuit breaker. Press the START button. If problem persists please call service.
9587	Node 3 motor fuse may be blown.	Cycle the circuit breaker. Press the START button. If problem persists please call service.
9588	Node 4 motor fuse may be blown.	Cycle the circuit breaker. Press the START button. If problem persists please call service.
9589	Node 5 motor fuse may be blown.	Cycle the circuit breaker. Press the START button. If problem persists please call service.
9590	Low film on Top roll.	Remove package from intake. Press the START button to resume wrapping.
9591	Low film on Bottom roll.	Remove package from intake. Press the START button to resume wrapping.

Error #	Message	What should I do?
9592	Memory error on node1.	Cycle the circuit breaker. Press the START button. If problem persists please call service.
9593	Memory error on node2.	Cycle the circuit breaker. Press the START button. If problem persists please call service.
9594	Memory error on node3.	Cycle the circuit breaker. Press the START button. If problem persists please call service.
9595	Memory error on node4.	Cycle the circuit breaker. Press the START button. If problem persists please call service.
9596	Memory error on node5.	Cycle the circuit breaker. Press the START button. If problem persists please call service.
9597	Wrap timings memory error on node1.	Cycle the circuit breaker. Press the START button. If problem persists please call service.
9598	Wrap timings memory error on node2.	Cycle the circuit breaker. Press the START button. If problem persists please call service.
9599	Wrap timings memory error on node3.	Cycle the circuit breaker. Press the START button. If problem persists please call service.
9600	Wrap timings memory error on node4.	Cycle the circuit breaker. Press the START button. If problem persists please call service.
9601	Wrap timings memory error on node5.	Cycle the circuit breaker. Press the START button. If problem persists please call service.
9627	Wrap box timings out of bounds not saved.	Cycle the circuit breaker. Press the START button. If problem persists please call service.
9628	Wrap box timings memory error.	Cycle the circuit breaker. Press the START button. If problem persists please call service.
9629	Too many wrap boxes write aborted.	Cycle the circuit breaker. Press the START button. If problem persists please call service.
9630	Too many wrap boxes read aborted.	Cycle the circuit breaker. Press the START button. If problem persists please call service.
9631	Package sensor across elevator is blocked.	Remove any packages, labels, debris in the machine. Press the START button. If problem persists please call service.
9632	Wrap box update timeout failure.	Cycle the circuit breaker. Press the START button. If problem persists please call service.
9633	Wrap box update memory failure.	Cycle the circuit breaker. Press the START button. If problem persists please call service.

Error #	Message	What should I do?
9634	Node1 communication failure. Reset the wrapper.	Cycle the circuit breaker. Press the START button.
9635	Node3 communication failure. Reset the wrapper.	Cycle the circuit breaker. Press the START button.
9636	Node4 communication failure. Reset the wrapper.	Cycle the circuit breaker. Press the START button.
9637	Node5 communication failure. Reset the wrapper.	Cycle the circuit breaker. Press the START button.
9639	Wrap box Timings Corruption.	
9640	Primary Intake has Stalled.	Remove any packages, labels, debris in the machine. Press the START button. If problem persists please call service.
9641	Secondary Intake has Stalled.	Remove any packages, labels, debris in the machine. Press the START button. If problem persists please call service.
9642	Elevator has Stalled.	Remove any packages, labels, debris in the machine. Press the START button. If problem persists please call service.
9643	Rear Folder has Stalled.	Remove any packages, labels, debris in the machine. Press the START button. If problem persists please call service.
9644	Front Folder has Stalled.	Remove any packages, labels, debris in the machine. Press the START button. If problem persists please call service.
9645	Side Folder has Stalled.	Remove any packages, labels, debris in the machine. Press the START button. If problem persists please call service.
9646	Side Clamp has Stalled.	Remove any packages, labels, debris in the machine. Press the START button. If problem persists please call service.
9647	Sealer belt has Stalled.	Remove any packages, labels, debris in the machine. Press the START button. If problem persists please call service.
9648	Centering conveyor jammed.	Remove any packages, labels, debris in the machine. Press the START button.
9649	Gripper has Stalled.	Remove any packages, labels, debris in the machine. Press the START button. If problem persists please call service.

Error #	Message	What should I do?
9650	Pusher has Stalled.	Remove any packages, labels, debris in the machine. Press the START button. If problem persists please call service.
9651	Sealer belt motor move error.	
9652	The Primary label is still at the printer.	
9653	The Second label is still at the printer.	
9654	The wrap timings are not compatible with the selected model.	Check model selection in wrapper system info.
9655	Gripper Failed to Close.	Remove any packages, labels, debris in the machine. Press the START button.
9656	Gripper Failed to Open.	Remove any packages, labels, debris in the machine. Press the START button.
9661	Side Clamp Failed to Close.	Remove any packages, labels, debris in the machine. Press the START button.
9662	Side Clamp Failed to Open.	Remove any packages, labels, debris in the machine. Press the START button.
9665	Upper Film Roll Failed to Switch.	Remove any packages, labels, debris in the machine. Press the START button.
9666	Lower Film Roll Failed to Switch.	Remove any packages, labels, debris in the machine. Press the START button.
9667	Film Selector Lever is unlatched.	Engage Film Selector Lever. Press the START button.
9668	Primary Applier Wand Failed to Home.	Remove any packages, labels, debris in the machine. Press the START button.
9669	Primary Applier Wand Failed to Move.	Remove any packages, labels, debris in the machine. Press the START button.
9670	Primary Applier Hand Failed to Home.	Remove any packages, labels, debris in the machine. Press the START button.
9671	Primary Applier Wand Vacuum Failure.	Remove any packages, labels, debris in the machine. Press the START button.
9672	Air Compressor Failure.	Remove any packages, labels, debris in the machine. Press the START button.
9673	Regulated Air Pressure Failure.	Remove any packages, labels, debris in the machine. Press the START button.
9674	Actuator Air Pressure Failure.	Remove any packages, labels, debris in the machine. Press the START button.

Error #	Message	What should I do?
9675	Bad Upper Film Pull.	Remove any packages, labels, debris in the machine. Press the START button.
9676	Bad Lower Film Pull.	Remove any packages, labels, debris in the machine. Press the START button.
9677	24V Power Supply Failure.	Remove any packages, labels, debris in the machine. Press the START button.
9678	170V Inrush Failure.	Remove any packages, labels, debris in the machine. Press the START button.
9679	170V Power Supply Failure.	Remove any packages, labels, debris in the machine. Press the START button.

Possible System Problems

If you are experiencing problems with the wrapper, label applier or printer, review the following scenarios.

Problem	Possible Cause	Action/Solution
There is no display on the display unit.	You may not have power running to the system.	Verify the following connections: <ul style="list-style-type: none"> • <i>Power switch on back of printer may be turned off.</i> • <i>Power cord is plugged into a working electrical outlet.</i> • <i>Power cord is plugged into the rear of the printer.</i> • <i>Display unit power cord is plugged into the printer.</i> • <i>USB cable is plugged into the printer.</i>
The Operator ID was not accepted.	You may have entered the wrong ID.	Verify that you are entering the proper ID. If correct, have your supervisor check the ID number.
Product number was not found.	You may have entered an invalid product number.	Verify the product number.
System prompts you to take a label. No label is present.	A portion of the label may be 'hidden' in the label exit.	Make sure that the label exit is clear.
Partial non-printed label is exposed.	The labels may be improperly threaded.	Verify that labels are properly threaded.

Problem	Possible Cause	Action/Solution
System prints blank labels, partially printed labels, or prints across multiple labels.	The labels may be improperly threaded or the printhead or roller may be dirty.	Check to see that labels are threaded properly. If the problem persists, refer to <i>Cleaning the Printhead</i> using the Hobart Printhead Cleaning Kit.
The package has an open side (incomplete wrap).	The film is not threaded correctly or centered correctly.	Refer to <i>Loading Film</i> for correct threading procedures.
	The side clamp pads are dirty causing film to slip out when being stretched.	Clean as required. Refer to <i>Cleaning and Maintaining your System</i> for detailed procedures.
	The product is outside the tray.	Rearrange product.
	Film roll turning on film arbor.	Tighten film collars.
The package has an open side or end (incomplete wrap).	The film selector rubber rollers are dirty.	Refer to <i>Cleaning and Maintaining your System</i> for detailed procedures.
	The tray or film is too slick or wet preventing the film from sticking.	Change the film or tray.
	Improper film size or the type of film is not suitable for machine wrapping.	Change the film.
There are holes in the film on the bottom of the package (tear or burn).	The sealer belt temperature is too high.	Verify sealer belt temperature. Normally, the sealer belt does not need to be hotter than 325° F (163° C).
	The elevator or side under folders are dirty.	Refer to <i>Cleaning and Maintaining your System</i> for detailed procedures.
	The film gripper pads and/or side clamp pads are dirty. --OR-- Foreign material is stuck inside the plates, causing film to slip out when being stretched.	Refer to <i>Cleaning and Maintaining your System</i> for detailed procedures.
	Damaged or defective film. This may be caused by improper storage, improper handling or excessive age.	Verify the film storage conditions. The film should be stored at a temperature between 50° F (10° C) and 70° F (21° C) and at a relative humidity of 50% to 85%.
	Improper film size or the type of film is not suitable for machine wrapping.	Change the film.
	Film tension set too high.	Adjust film tension.

Problem	Possible Cause	Action/Solution
Package is not sealed or closed on the bottom.	The sealer belt temperature is set too low or off.	Adjust the temperature. Refer to <i>Modifying the Wrapper Settings</i> for detailed procedures.
	Foreign material in gripper or the gripper is dirty.	Refer to <i>Cleaning and Maintaining your System</i> for detailed procedures.
	Too many layers of film on the bottom of the package. A small tray may have been wrapped with wide film.	Verify the film selection.
	The film selector rubber rollers are dirty.	Refer to <i>Cleaning and Maintaining your System</i> for detailed procedures.
	Improper film size or type of film is not suitable for machine wrapping.	Change the film.
	Film roll is loose on film arbor.	Tighten film collars.
Package has tails.	The film gripper pads are dirty.	Refer to <i>Cleaning and Maintaining your System</i> for detailed procedures.
	The elevator is dirty causing trays to slide too far onto the elevator.	Refer to <i>Cleaning and Maintaining your System</i> for detailed procedures.
	Improper film size or type of film is not suitable for machine wrapping.	Change the film.
Package rolls on the intake.	The package was loaded incorrectly.	Verify the package height versus the package length.
	The package was placed too far off center.	Center the package on the intake sensor.
	The product was hanging over the edges of the tray.	Re-adjust the product on the tray.
	The intake shelf is dirty.	Refer to <i>Cleaning and Maintaining your System</i> for detailed procedures.
Package jams.	The product was loaded on the tray incorrectly.	Re-adjust the product on the tray.
	The film is not threaded correctly.	Refer to <i>Loading Film</i> for detailed procedures.
	The package was placed too far off center.	Center the package on the intake sensor.
	The package fed into the machine in the wrong direction.	Verify the package height versus the package length.

Problem	Possible Cause	Action/Solution
Intake pusher will not cycle.	The package is over 15 lbs.	Hand wrap or re-pack the package.
	The system is at the <i>Run Screen</i> .	Select a PLU to begin.
	The scale is not zero.	Remove any weight from the platter and try again.
	Wrapper in label only mode.	Verify wrap and apply buttons are enabled.
The wrapper will not run, and the start (green) button is not lit.	The power cords are not plugged in.	Verify that the power connections are secure.
	The main electrical switch is in the OFF position.	Turn the main power switch ON.
	The circuit breaker at the building electric panel is off.	Verify that the circuit breaker is ON.
	The store circuit protector is open.	Verify that the circuit protector is closed.
The wrapper will not run, but the start (green) button is lit.	There is an unresolved error in the system. --OR-- The stop (red) switch was not cycled after the error was resolved.	Check the console for the error and follow up procedures.
	Wrapper in label only mode.	Verify wrap and apply buttons are enabled.
The <i>Scale Warm-Up</i> message won't go away.	Weight may be on the platter.	Make sure the platter/weigher is clear. Power the printer down and up using the switch on the back.
The system won't accept the date & time.	You may have entered information in an incorrect format.	Verify that you are entering a valid date & time.
Over gross weight displays on screen.	There is too much weight on the platter/weigher.	Rezero weigher.
Package not wrapped at all.	Machine is in Apply/Label Mode.	Reset system to Wrap Mode.
Label jammed.	Out of labels.	Load label stock.

Chapter 6: NGW (2P) With Secondary Label Applier

About the NGW with Secondary Label Applier

The NGW (2P) with a second printer functions similarly to the single printer version. The secondary printer on the NGW can be used for pre-printed labels or to print labels. The NGW (2P) employs 2 EPP printers and a 15.6" display. This section details key differences in operation from the single printer version.

Secondary Labels

Any PLU can have a secondary label type assigned to it. If there is a secondary label type assigned, the NGW will place a secondary label on the package based on the label type assigned.

This section outlines instructions on:

- How to Change Label Placement (temporary overrides).
- How to Add a secondary label type to a PLU (temporary override).

Label Placement Overrides

How To Change Label Placement (Temporary Overrides):

There are 2 ways to temporarily change the label placement:

1. Use preset flashkeys to toggle between label placement.
2. Navigate to the label placement screen and manually change the label placement.

Creating a flashkey for changing label placement is a quick method of making minor placement modifications. If there are flashkeys set up for label placement, the NGW will be set to use the default label placement. Below is an example of how to use label placement flashkeys.

To change label placement (temporary override) using preset flashkeys:

1. TOUCH Label Placement 2 for the alternate label placement configuration.
2. TOUCH Default Label Placement to switch back.

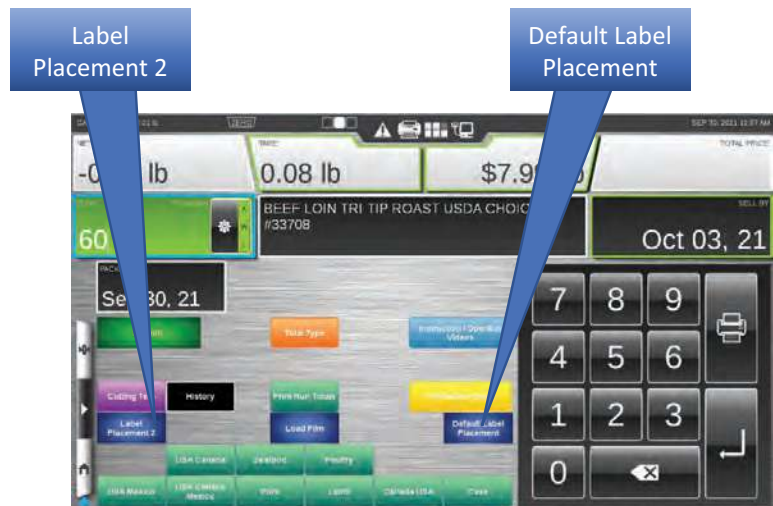

NOTE: Flash keys can be labeled with any text desired.

To change label placement (temporary override) using the label placement screen:

1. Navigate to the label placement screen.
2. TOUCH 1, and then TOUCH the desired position for the primary label.
3. TOUCH 2, and then TOUCH the desired position for the secondary label.
4. Use the rotation wheel to adjust the orientation of each label.



Rotation Wheel

NOTE: The labels can be placed anywhere a green square is present.

NOTE: Label Placement Overrides are temporary. Any time PLU data is refreshed, original label types and positions will be restored. Permanent changes to PLU data or label types must be done in supervisor mode.

Adding a Secondary Label to a PLU (Temporary Override)

If a PLU is missing a secondary label type, it can be temporarily added in a few easy steps.

1. Enter PLU.
2. Swipe to Product Information screen (right screen).
3. **TOUCH Additional Label ID.**
4. Enter the desired secondary label type for either a non-printed or printed label.



NOTE: PLU Data Overrides are temporary. Any time PLU data is refreshed, original label types will be restored. Permanent changes to PLU data or label types must be done in supervisor mode.

Index

A

About Proper Care, 4-1
 About the NGW with Secondary Label Applier, 6-1
 Adding a Secondary Label to a PLU (Temporary Override), 6-4

C

Center Operator Screen, 3-5
 Cleaning and Maintaining your System, 4-1
 Cleaning Each Component, 4-5
 Cleaning Instructions, 4-4
 Cleaning the Printhead, 4-14
 Cleaning/Rinsing Guidelines, 4-3
 Communication Connections, 2-2
 Component Cleaning Table, 4-5

E

Ejecting Media, 3-23
 Electrical Connections, 2-1
 Enemies of Stainless Steel, 4-1

F

FCC Note, 1-1
 Fixed Features on the Operator Screen, 2-4

G

Guidelines, 4-2

H

Help, 3-12

I

Important Information, 1-2

K

Keypad and Keyboard Icons, 2-9

L

Label Placement Overrides, 6-2
 Loading Film, 2-11
 Loading Labels, 4-11
 Logging onto the System, 3-4

M

Menu Icon Features, 2-7
 Modifying the Label Placement, 3-30
 Modifying the Operator Screens, 3-7
 Modifying the Printer Settings, 3-19
 Modifying the Wrapper Settings, 3-29

N

NGW Wrapping System, 1-1

O

Operation Mode, 3-13
 Operator Manual Terminology, 1-2
 Operator Screens Overview, 2-3

P

Possible System Problems, 5-11
 Power Up the System, 3-1
 Printhead Cleaning Kit, 4-14
 Printhead cleaning kit part number, 4-14

R

Reboot Button, 3-2, 3-3
 Removing Labels, 4-9
 Reviewing System Errors, 5-3
 Rezero the Weigher, 3-22
 Right Operator Screen, 3-6
 Running a Product, 3-16

S

Sanitizing Guidelines, 4-4
 Search by Description, 3-11
 Search by PLU, 3-11
 Secondary Labels, 6-1
 Select a Total Type, 3-21
 Selecting Film, 2-9
 Setting the Label Size Plate, 4-13
 Shutting Down the System, 3-2, 3-3
 Storing Film, 2-9

T

Troubleshooting, 5-1

U

Understand Package Weights, Size, Shape and Range Guidelines, 2-10
 Understanding the System, 2-1
 Understanding the Wrapper, 2-9
 Using Create COOL, 3-18
 Using the Flashkey Editor, 3-27
 Using the NGW Wrapping System, 3-1
 Using the Search Function, 3-11
 Using Trays, 2-10

V

Verify Correctness of Weight and Price, 1-2
 Viewing About Scale Information, 3-26
 Viewing Operator Note, 3-24
 Viewing Product Notes, 3-23
 Viewing Weights & Measures Information, 3-25
 Void a Transaction, 3-21

