



Decathlon Series Gas Fryers (D & HD Models) Installation & Operation Manual

D, SCFD, CFD, YHBT#14, HBT#50 Models
HD, SCFHD Models
FRYMASTER FPD65, FPHD65, FPLHDC65 Models

⚠ CAUTION
**READ THE INSTRUCTIONS BEFORE USING THE
FRYER.**

 **FRYMASTER®**

NON-CE &



Frymaster, a member of the Commercial Food Equipment Service Association, recommends using CFESA Certified Technicians.

24-Hour Service Hotline 1-800-551-8633

www.frymaster.com

E-mail: fryservice@welbilt.com

Original Instructions



06/2020

Please read all sections of this manual and retain for future reference.

NOTICE

IF, DURING THE WARRANTY PERIOD, THE CUSTOMER USES A PART FOR THIS FRYMASTER FOOD SERVICE EQUIPMENT OTHER THAN AN **UNMODIFIED NEW OR RECYCLED PART** PURCHASED DIRECTLY FROM DEAN, OR ANY OF ITS AUTHORIZED SERVICERS, AND/OR THE PART BEING USED IS MODIFIED FROM ITS ORIGINAL CONFIGURATION, THIS WARRANTY WILL BE VOID. FURTHER, DEAN AND ITS AFFILIATES WILL NOT BE LIABLE FOR ANY CLAIMS, DAMAGES OR EXPENSES INCURRED BY THE CUSTOMER WHICH ARISE DIRECTLY OR INDIRECTLY, IN WHOLE OR IN PART, DUE TO THE INSTALLATION OF ANY MODIFIED PART AND/OR PART RECEIVED FROM AN UNAUTHORIZED SERVICER.

NOTICE

This appliance is intended for professional use **only** and is to be operated by qualified personnel only. A Frymaster Factory Authorized Servicer (FAS) or other qualified professional should perform installation, maintenance, and repairs. Installation, maintenance, or repairs by unqualified personnel may void the manufacturer's warranty. See Chapter 1 of this manual for definitions of qualified personnel.

NOTICE

This equipment must be installed in accordance with the appropriate national and local codes of the country and/or region in which the appliance is installed. For the United States and Canada these are the National Fuel Gas Code, ANSI Z233.1/NFPA 54, or the Natural Gas and Propane Installation Code, CSA B149.1. See NATIONAL CODE REQUIREMENTS in Chapter 3 of this manual for specifics.

The gas manifold of this appliance or of the battery of which it is a part must be connected to a gas appliance pressure regulator adjusted for the manifold pressure marked on the rating plate.

The appliance and its individual shutoff valve must be disconnected from the gas supply piping system during any pressure testing of that system at test pressures in excess of ½ psi (3.5 kPa/13.84 inches W.C.).

The appliance must be isolated from the gas supply piping system by closing its individual manual shutoff valve during any pressure testing of the gas supply piping system at test pressures equal to or less than ½ psi (3.5 kPa/13.84 inches W.C.).

NOTICE TO OWNERS OF UNITS EQUIPPED WITH COMPUTERS

U.S.

This device complies with Part 15 of the FCC rules. Operation is subject to the following two conditions: 1) This device may not cause harmful interference, and 2) This device must accept any interference received, including interference that may cause undesired operation. While this device is a verified Class A device, it has been shown to meet Class B limits.

CANADA

This digital apparatus does not exceed the Class A or B limits for radio noise emissions as set out by the ICES-003 standard of the Canadian Department of Communications.

Cet appareil numérique n'émet pas de bruits radioélectriques dépassant les limites de classe A et B prescrites dans la norme NMB-003 édictée par le Ministre des Communications du Canada.



DANGER

Improper installation, adjustment, maintenance or service, and unauthorized alterations or modifications can cause property damage, injury, or death. Read the installation, operating and service instructions thoroughly before installing or servicing this equipment. Only qualified service personnel may convert this appliance to use a gas other than that for which it was originally configured. See Chapter 1 of this manual for definition of qualified service personnel.

NOTICE

The appliance must be installed and used in such a way that any water cannot contact the fat or oil.

⚠ WARNING

After installation of a gas fryer and after any maintenance to the gas system of a gas fryer-manifold, valve, burners, etc. – check for gas leaks at all connections. Apply a thick soapy solution to all connections and ensure there are no bubbles. There should be no smell of gas.

NOTICE

The Commonwealth of Massachusetts requires any and all gas products to be installed by a licensed plumber or pipe fitter.

NOTICE TO U.S. CUSTOMERS

This equipment is to be installed in compliance with the basic plumbing code of the Building Officials and Code Administrators International, Inc. (BOCA) and the Food Service Sanitation Manual of the U.S. Food and Drug Administration.

⚠ DANGER

Adequate means must be provided to limit the movement of this appliance without depending upon the gas line connectors or associated piping.

Single fryers equipped with legs must be stabilized by installing anchor straps.

All fryers equipped with casters must be stabilized by installing restraining chains. If a flexible gas line is used, an additional restraining cable must be connected at all times when the fryer is in use.

All fryers equipped with casters must be installed using a connector that complies with the Standard for Connectors for Moveable Gas Appliances, ANSI Z21.69 or CSA 6.16, and a quick-disconnect device that complies with the Standard for Quick-Disconnect Devices for Use with Gas Fuel, ANSI Z21.41 or CSA 6.9.

⚠ DANGER

When installed, this appliance must be electrically grounded in accordance with local codes, or in the absence of local codes, with the National Electrical Code, ANSI/NFPA 70, the Canadian Electrical Code, CSA C22.2, or the appropriate national code of the country in which installed.

NOTICE

Drawings and photos used in this manual are intended to illustrate operational, cleaning and technical procedures and may not conform to onsite management operational procedures.

⚠ DANGER

The front ledge of the fryer is not a step. Do not stand on the fryer. Serious injury can result from slips or contact with the hot oil.

⚠ CAUTION

No warranty is provided for any Frymaster fryer used in a mobile or marine installation or concession. Warranty protection is only offered for fryers installed in accordance with the procedures described in this manual. Mobile, marine or concession conditions of this fryer should be avoided to ensure optimum performance.

⚠ DANGER

Do not store or use gasoline or other flammable vapors and liquids in the vicinity of this or any other appliance.

⚠ DANGER

Do not spray aerosols in the vicinity of this appliance while it is in operation.

⚠ WARNING

Do not use water jets or a steam cleaner to clean this equipment.

 **DANGER**

Instructions to be followed in the event the operator smells gas or otherwise detects a gas leak must be posted in a prominent location. This information can be obtained from the local gas company or gas supplier.

 **DANGER**

The crumb tray in fryers equipped with a filter system must be emptied into a fireproof container at the end of frying operations each day. Some food particles can spontaneously combust if left soaking in certain shortening material. Additional information can be obtained in the filtration manual included with the system.

NOTICE

This appliance is intended to be used for commercial applications, for example in kitchens of restaurants, canteens, hospitals and in commercial enterprises such as bakeries, butcheries, etc., but not for continuous mass production of food.

 **DANGER**

This appliance must be connected to a power supply having the same voltage and phase as specified on the rating plate located on the inside of the appliance door.

 **WARNING**

Use caution and wear appropriate safety equipment to avoid contact with hot oil or surfaces that may cause severe burns or injury.

 **WARNING**

Do not block the area around the base or under the fryers.

 **WARNING**

This appliance is not intended for use by children under the age of 16 or persons with reduced physical, sensory or mental capabilities, or lack of experience and knowledge, unless they have been given supervision concerning use of the appliance by a person responsible for their safety. Do not allow children to play with this appliance.

 **WARNING**

If the electrical power supply cord is damaged, it must be replaced by a Factory Authorized Servicer or a similarly qualified person in order to avoid a hazard.

 **WARNING**

No structural material on the fryer should be altered or removed to accommodate placement of the fryer under a hood. Questions? Call the Dean Service Hotline at 1-800-551-8633.

 **WARNING**

Do not bang fry baskets or other utensils on the fryer's joiner strip. The strip is present to seal the joint between the frypot. Banging fry baskets on the strip to dislodge shortening will distort the strip, adversely affecting its fit. It is designed for a tight fit and should only be removed for cleaning.

 **DANGER**

With prolonged use, the flashpoint of old oil is reduced and may be prone to surge boiling. Discard the OIL if it shows signs of excessive smoking or foaming. Serious burns, personal injury, fire, and/or property damage could result.

 **WARNING**

Operation, installation, and servicing of this product may expose you to chemicals/products including [Bisphenol A (BPA), glass wool or ceramic fibers, and crystalline silica], which is [are] known to the State of California to cause cancer, birth defects or other reproductive harm. For more information go to www.P65Warnings.ca.gov.

 **WARNING**

Use caution when dropping wet food or water into the hot oil. It may cause spattering of the oil, which may cause severe burns

 **WARNING**

Do not leave the fryer unattended during use.

 **WARNING**

Use caution when dropping wet food or water into the hot oil. It may cause spattering of the oil, which may cause severe burns

 **WARNING**

Do not overfill the frypot to avoid overflow of hot oil that may cause severe burns, slipping and falling.

 **WARNING**

Use caution and wear appropriate safety equipment when adding oil to the fryer, to prevent splashing of hot oil, which may cause severe burns.

 **WARNING**

Use caution when dropping large amounts of food into the hot oil. It may cause large amounts of foaming, which can overflow and may cause burns.

 **WARNING**

Opening the drain valve will lead to the outflow of the hot contents of the fryer that can cause injury.



High Efficiency Decathlon (HD) Series Gas Fryers Installation & Operation Manual

TABLE OF CONTENTS

	Page #
1. INTRODUCTION.....	1-1
1.1 Applicability and Validity.....	1-1
1.2 After Purchase.....	1-1
1.3 Ordering Parts.....	1-1
1.4 Service Information.....	1-2
1.5 Computer Information.....	1-2
1.6 Safety Information.....	1-3
1.7 Service Personnel.....	1-3
2. IMPORTANT INFORMATION.....	2-1
2.1 Receiving and Unpacking Equipment.....	2-1
2.2 General.....	2-1
2.3 Product Description.....	2-2
2.4 Principles of Operation.....	2-2
2.5 Rating Plate.....	2-3
2.6 Pre-Installation.....	2-3
2.7 Air Supply and Ventilation.....	2-5
2.8 Equipment Installed at High Altitudes.....	2-5
3. INSTALLATION.....	3-1
3.1 Installing the Fryer.....	3-1
3.2 Leveling the Fryer (Fryers equipped with legs only).....	3-1
3.3 Installing Casters and Legs.....	3-2
3.4 Gas Connections.....	3-3
3.5 Gas Specifications.....	3-6
3.6 Gas Adjustment.....	3-7
3.7 Gas Conversion Procedures.....	3-7
3.8 Electrical Connections.....	3-9



**High Efficiency Decathlon (HD) Series Gas Fryers
Installation & Operation Manual**

TABLE OF CONTENTS (CONT.)

	Page #
4. FRYER OPERATIONS	4-1
4.1 Initial Start-up.....	4-1
4.2 Boil-Out Procedure.....	4-3
4.3 Final Preparation.....	4-5
5. CONTROLLER OPERATING INSTRUCTIONS	5-1
5.1 Operating Instructions: Electronic Thermostat Controller.....	5-1
5.2 Electronic Thermostat Controller/Computer with Back-Up Thermostat.....	5-2
6. FILTRATION	6-1
6.1 General.....	6-1
6.2 Filter Preparation.....	6-1
6.3 Daily Filter Operation.....	6-2
6.4 Operating the Filter.....	6-2
7. PREVENTATIVE MAINTENANCE	7-1
7.1 Daily.....	7-1
7.2 Weekly.....	7-1
7.3 Periodic/Annual.....	7-2
7.4 Stainless Steel Care.....	7-2
8. TROUBLESHOOTING	8-1
8.1 Pilot Burner Malfunction.....	8-1
8.2 Main Burner Malfunctions.....	8-2
8.3 Electronic Thermostat Calibration.....	8-3

DECATHLON (D & HD) SERIES GAS FRYERS

CHAPTER 1: INTRODUCTION

1.1 Applicability and Validity

The Decathlon Series gas model family (D and HD models) has been approved by the European Union (EU) for sale and installation in the following EU countries: AT, BE, KE, KD, ES, FI, FR, GB, IE, IT, LU, NL, NO, PT and SE.

This manual is applicable to and valid for all Decathlon gas units sold in English-speaking countries, including those in the European Union. This manual is applicable to and valid for all High Efficiency Decathlon gas units sold in English-speaking countries, excluding the European Union. Where conflicts exist between instructions and information in this manual and local or national codes of the country in which the equipment is installed, installation and operation shall comply with those codes.

This appliance is only for professional use and shall be used by qualified personnel as defined in Section 1.7.

1.2 After Purchase

In order to improve service, have the following chart filled in by the Frymaster Authorized Service Technician who installed this equipment.

Authorized Service
Technician/FAS
Address

Telephone/Fax
Model Number
Serial Number
Gas Type

1.3 Ordering Parts

Customers may order parts directly from their local factory authorized service center. For this address and phone number, contact your factory authorized servicer or call the Frymaster Service Hotline phone number, 1-800-551-8633.

To speed up your order, provide the model number, serial number, gas type, part needed, item part number (if known), and quantity needed.

HIGH EFFICIENCY DECATHLON (HD) SERIES GAS FRYERS

CHAPTER 1: INTRODUCTION

1.4 Service Information

Call the Frymaster Service Hotline, 1-800-551-8633, for the location of your nearest factory authorized service center. To assist you more efficiently, always provide the service technician with the model number, gas type, serial number, and the nature of the problem.

1.5 Computer Information

This equipment has been tested and found to comply with the limits for a Class A digital device, pursuant to Part 15 of the FCC rules. While this device is a verified Class A device, it has been shown to meet the Class B limits. These limits are designed to provide reasonable protection against harmful interference when the equipment is operated in a commercial environment. This equipment generates, uses, and can radiate radio frequency energy and may cause harmful interference to radio communications if not installed and used in accordance with the instruction manual. Operation of the equipment in a residential area is likely to cause harmful interference in which case the user will be required to correct the interference at his/her own expense.

The user is cautioned that any changes or modifications not expressly approved by the party responsible for compliance could void the user's authority to operate the equipment.

If necessary, the user should consult the dealer or an experienced radio and television technician for additional suggestions.

The user may find the following booklet prepared by the Federal Communications Commission helpful: "How to Identify and Resolve Radio-TV Interference Problems". This booklet is available from the U.S. Government Printing Office, Washington, DC 20402, Stock No. 004-000-00345-4.

1.6 Safety Information

Before attempting to operate your unit, read the instructions in this manual thoroughly.

Throughout this manual, you will find notations enclosed in double-bordered boxes similar to the ones below.

 **CAUTION**

CAUTION boxes contain information about actions or conditions that *may cause or result in a malfunction of your system.*

 **WARNING**

WARNING boxes contain information about actions or conditions that *may cause or result in damage to your system,* and which may cause your system to malfunction.

 **DANGER**

DANGER boxes contain information about actions or conditions that *may cause or result in injury to personnel,* and which may cause damage to your system and/or cause your system to malfunction.

HIGH EFFICIENCY DECATHLON (HD) SERIES GAS FRYERS
CHAPTER 1: INTRODUCTION

1.7 Service Personnel

A. Qualified and/or Authorized Operating Personnel

1. Qualified/authorized operating personnel are those who have carefully read the information in this manual and have familiarized themselves with the equipment functions, or have had previous experience with the operation of equipment covered in this manual.

B. Qualified Installation Personnel

1. Qualified installation personnel are individuals, firms, corporations, and/or companies, that, either in person or through a representative, are engaged in and responsible for the installation of gas-fired appliances. Qualified personnel must be experienced in such work, be familiar with all gas precautions involved, and have complied with all requirements of applicable national and local codes.

C. Qualified Service Personnel

1. Qualified service personnel are those who are familiar with Frymaster equipment and have been authorized by Frymaster to perform service on Frymaster equipment. All authorized service personnel are required to be equipped with a complete set of service parts manuals and stock a minimum amount of parts for Frymaster equipment. A list of Frymaster Factory Authorized Servicers (FASs) is located online at www.frymaster.com.
2. *Failure to use qualified service personnel will void the Frymaster warranty on your equipment.*

DECATHLON (D & HD) SERIES GAS FRYERS

CHAPTER 2: IMPORTANT INFORMATION

2.1 Receiving and Unpacking Equipment

- A. Check that the container is upright. Use an outward prying motion - ***no hammering*** - to remove the carton. Unpack the fryer carefully and remove all accessories from the carton. Do not discard or misplace these, as they will be needed.
- B. After unpacking, immediately check the equipment for visible signs of shipping damage. If damage has occurred, contact the carrier and file the appropriate freight claims. Do not contact the factory. Shipping damage responsibility is between the carrier and the dealer.

If your equipment arrives damaged:

1. File claim for damages immediately, regardless of extent of damage.
2. Visible loss or damage: Be sure this is noted on the freight bill or express receipt and is signed by the person making the delivery.
3. Concealed loss or damage: If damage is unnoticed until equipment is unpacked, notify freight company or carrier immediately, and file a concealed damage claim. This should be done within 15 days of date of delivery. Be sure to retain container and all packing materials for inspection.

NOTE: Frymaster Does Not Assume Responsibility for Damage or Loss Incurred in Transit.

- C. **Frying systems with built-in filtration:** Take off the filter support brace and remove the filter pan from the cabinet.
- D. **Decathlon four-battery systems:** Casters are pre-installed on the frying system and the carton is furnished with three unloading ramps. Remove the braces from the front casters by taking out the securing bolts. Carefully roll the unit down the ramps from the front (cooking side).
- E. Remove all plastic skin from sides, front, and doors of the fryer(s). Failure to do this prior to initial fryer operation will make it very difficult to remove later.

2.2 General

Qualified, licensed, and/or authorized installation or service personnel only (as defined in Section 1.6) should perform the following:

- **Installation and service on Frymaster equipment.**
- **Conversion of this appliance from one gas type to another.**

Failure to use qualified, licensed, and/or authorized installation or service personnel to install, convert to another gas type or otherwise service this equipment will void the Frymaster warranty and may result in damage to the equipment or injury to personnel.

HIGH EFFICIENCY DECATHLON (HD) SERIES GAS FRYERS

CHAPTER 2: IMPORTANT INFORMATION

2.2 General (cont.)

Where conflicts exist between instructions and information in this manual and local code or national codes, or regulations, installation and operation shall comply with the codes or regulations in force in the country in which the equipment is installed.

 **DANGER**

Building codes prohibit a fryer with its open tank of hot oil/shortening from being installed beside an open flame of any type, including those of broilers and ranges.

Upon arrival, inspect the fryer carefully for visible or concealed damage. (See *Receiving and Unpacking Equipment* in Section 2.1.)

 **CAUTION**

Frymaster appliances equipped with legs are for stationary installations. Appliances fitted with legs must be lifted during movement to avoid damage to the appliance and bodily injury. For moveable installations, optional equipment casters must be used. Questions? Call 1-800-551-8633.

2.3 Product Description

Decathlon Series gas fryers are energy efficient, tube-style, gas-fired units. All units are shipped completely assembled with accessories packed inside the frypot. All units are adjusted, tested and inspected at the factory before shipment. Sizes, weights and input rates of all models are listed in this manual.

 **WARNING**

The on-site supervisor is responsible for ensuring that operators are made aware of the inherent hazards of operating a hot oil frying system, particularly the aspects of system operation, oil filtration, draining and cleaning procedures.

2.4 Principles of Operation

The incoming gas flows through orifices and is mixed with air in the burners to create the correct ratio for proper combustion. The mixture is ignited at the front end of each heat tube by the pilot light. Internal diffusers slow the flame as it goes through the burner tube. This slow, turbulent flame increases heat transfer to the walls of the tubes to heat the oil more efficiently.

HIGH EFFICIENCY DECATHLON (HD) SERIES GAS FRYERS

CHAPTER 2: IMPORTANT INFORMATION

2.5 Rating Plate

This is attached to the inside front door panel. Information provided includes the model and serial number of the fryer, BTU/hr input of the burners, outlet gas pressure in inches W.C. and whether the unit has natural or propane gas orifices.

 **DANGER**
Fryers *MUST* be connected *ONLY* to the gas type identified on the attached rating plate.

2.6 Pre-installation

 **DANGER**
No structural material on the fryer should be altered or removed to accommodate placement of the fryer under a hood. Questions? Call the Frymaster Service Hotline at 1-800-551-8633.

 **DANGER**
Do not connect this appliance to the gas supply before reviewing all information in this chapter.

A. Weight of Equipment

Model	Weight	Model	Weight	Model	Weight
D150	180lbs (82 kg)	SCFHD250G	397lbs (180 kg)	FPHD165	400lbs (181 kg)
D160	255lbs (116 kg)	SCFHD350G	610lbs (277kg)	FPHD265	750lbs (340 kg)
SCFD250G	397lbs (180kg)	SCFHD450G	910lbs (413kg)	FPHD365	1100lbs (499 kg)
SCFD350G	610lbs (277kg)	SCFHD550G	1,311lbs (595kg)	FPHD465	1400lbs (635 kg)
SCFD450G	910lbs (413kg)	SCFHD260G	417lbs (189kg)	FPHD565	750/1100 lbs (340/499 kg) (2 crates)
SCFD550G	1,311lbs (595kg)	SCFHD360G	815lbs (370kg)	FPHD665	750/1400 lbs (340/635 kg) (2 crates)
SCFD260G	417lbs (189kg)	SCFHD460G	1,295lbs (587kg)	FPLHDC165	260lbs (118 kg)
SCFD360G	815lbs (370kg)	FPD165	400lbs (181 kg)	FPLHDC265	750lbs (340 kg)
SCFD460G	1,295lbs (587kg)	FPD265	750lbs (340 kg)	FPLHDC365	1100lbs (499 kg)
YHBT114G	180lbs(82 kg)	FPD365	1100lbs (499 kg)	FPLHDC465	1400lbs (635 kg)
HBT150G	180lbs(82 kg)	FPD465	1400lbs (635 kg)	FPLHDC565	750/1100 lbs (340/499 kg) (2 crates)
HD150	180lbs(82 kg)	FPD565	750/1100 lbs (340/499 kg) (2 crates)	FPLHDC665	50/1400 lbs (340/635 kg) (2 crates)
HD160	255lbs(116 kg)	FPD665	750/1400 lbs (340/635 kg) (2 crates)		

**HIGH EFFICIENCY DECATHLON (HD) SERIES GAS FRYERS
CHAPTER 2: IMPORTANT INFORMATION**

B. General: Only licensed personnel should install any gas-fired equipment.

1. A manual gas shut-off valve must be installed in the gas supply line ahead of the fryers for safety and ease of future service.
2. Decathlon Series gas fryers require 120VAC 60 cycle or 230VAC single-phase 50 Hz (International) electrical service and are equipped with a 16-3 SJT grounded flexible power cord for a direct connection to the power supply. Amperage draw for each unit depends on the accessories supplied with the unit/system.

C. Clearances: The fryer area must be kept free and clear of all combustibles. This unit is design-certified for the following installations:

1. Commercial installation only (not for household use).
2. Non-combustible floor installation equipped with factory-supplied 6 in. (15 cm) adjustable legs or 5 in. (13 cm) casters;
3. Combustible construction with a minimum clearance of 6 in. (15 cm) side and 6 in. (15 cm) rear, and equipped with factory-supplied 6 in. (15 cm) adjustable legs or 5 in. (13 cm) casters.

2.6 Pre-installation (cont.)

C. Installation Standards

<p>1. <u>U.S. installations must meet:</u></p> <p>American National Standard Institute ANSI Z83.11 American Gas Association 8501 E. Pleasant Valley Road Cleveland, OH 44131</p> <p>National Electrical Code ANSI/NFPA #70 American National Standard Institute 1430 Broadway New York, NY 10018</p> <p>NFPA Standards #96 and #211 National Fire Protection Association 470 Atlantic Avenue Boston, MA 02110</p>	<p>2. <u>Canadian installations must meet:</u></p> <p>CAN 1-B149 Installation Codes Canadian Gas Association 55 Scarsdale Road Don Mills, ONT, M3B 2R3</p> <p>Canadian Electric Code c22.1, part 1 Canadian Standards Association 178 Rexdale Blvd. Rexdale, ONT, M9W 1R3</p>
<p>3. <u>CE/Export Standards:</u> Fryer installation must conform with local codes, or, in the absence of local codes, to the appropriate national or European Community (CE) standards.</p>	

HIGH EFFICIENCY DECATHLON (HD) SERIES GAS FRYERS
CHAPTER 2: IMPORTANT INFORMATION

2.7 Air Supply and Ventilation



This appliance must be installed with sufficient ventilation to prevent the occurrence of unacceptable concentrations of substances harmful to the health of personnel in the room in which it is installed.

Keep the area around the fryer clear to prevent obstruction of combustion and ventilation airflow as well as for service and maintenance.

- A. Do not connect this fryer to an exhaust duct.
- B. Correct installation and adjustment will ensure adequate airflow to the fryer system.
- C. A commercial, heavy-duty fryer must vent its combustion wastes to the outside of the building. A deep-fat fryer must be installed under a powered exhaust hood, or an exhaust fan must be provided in the wall above the unit, as exhaust gas temperatures are approximately 800-1000°F (427-538°C). Check air movement during installation. Strong exhaust fans in the exhaust hood or in the overall air conditioning system can produce slight air drafts in the room.
- D. Do not place the fryer's flue outlet directly into the plenum of the hood, as it will affect the gas combustion of the fryer.
- E. Never use the interior of the fryer cabinet for storage or store items on shelving over or behind the fryer. Exhaust temperatures can exceed 800°F (427°C) and may damage or melt items stored in or near the fryer.
- F. Adequate distance must be maintained from the flue outlet of the fryer(s) to the lower edge of the filter bank. Per NFPA Standards No. 96, a minimum of 18 in. (45 cm) should be maintained between the flue(s) and the lower edge of the exhaust hood filter.
- G. Filters and drip troughs should be part of any industrial hood, but consult local codes before constructing and installing any hood. The duct system, the exhaust hood and the filter bank must be cleaned on a regular basis and kept free of grease.

2.8 Equipment Installed at High Altitudes

- A. The fryer input rating (BTU/hr) is for elevations up to 2,000 ft (610 m). For elevations above 2,000 ft (610m), the rating should be reduced four percent for each additional 1,000 ft (305m) above sea level.
- B. The correct orifices are installed at the factory if operating altitude is known at time of the customer's order.

DECATHLON (D & HD) SERIES GAS FRYERS

CHAPTER 3: INSTALLATION

3.1 Installing the Fryer

- A. **Initial Installation:** If the fryer is installed with legs, do not push the fryer to adjust its position. Use a pallet or lift jack to lift the fryer slightly, and then place the fryer where it is to be installed.
- B. **Relocating the fryer:** Remove all weight from each leg before moving a fryer with legs installed. Do not slide the fryer on the legs.
- C. If a leg becomes damaged, contact your service agent for immediate repair/replacement.

3.2 Leveling the Fryer (Fryers equipped with legs only)

- A. **All Installations:** If the floor is uneven or has a definite slope, place the fryer on a level platform.
- B. Place a carpenter's spirit level across the top of the fryer and level the unit both front-to-back and side-to-side. If it is not level, the unit may not function efficiently, the oil may not drain properly for filtering and in a line-up it may not match adjacent units.
- C. Adjust to the high corner and measure with the spirit level. If floor is uneven, level the unit with the screw adjustments on each leg (**ensure minimum clearances as discussed in Chapter 2 are maintained during the leveling procedure**).
- D. **Re-leveling:** If the fryer is moved, re-level the fryer following the above instructions.
- E. The install must be reviewed at the time of installation to ensure it meets the intent of these instructions.

 **CAUTION**

Fryers must be at room temperature, empty of oil, and if fitted with legs, lifted during movement to avoid damage and possible bodily injury.

 **DANGER**

Hot shortening can cause severe burns. Avoid contact. Under all circumstances, oil must be removed from the fryer before attempting to move it to avoid oil spills, and the falls and severe burns that could occur. This fryer may tip and cause personal injury if not secured in a stationary position.

HIGH EFFICIENCY DECATHLON (HD) SERIES GAS FRYERS

CHAPTER 3: INSTALLATION

3.3 Installing Casters and Legs

- A. Install casters and/or legs near where the fryer is to be used, as neither is secure for long transit. Decathlon Series gas fryers cannot be curb-mounted and must be equipped with either legs or casters provided.
- B. After unpacking, use a pallet or lift jack to raise the unit before installing the casters.
- C. Align the caster or leg base holes with the leg support assembly and insert bolt. Install the washers and nut hand tight, and repeat for all four holes in caster/leg base assembly.
- D. Tighten the caster/leg against the leg support assembly by using appropriate tools. Ensure that all four bolts are evenly tightened. Tighten the bolts to 50 inch-lbs. (5.65 Nm) torque.
- E. **For fryer with casters, there are no built-in leveling devices.** The floor where the fryers are installed must be level.

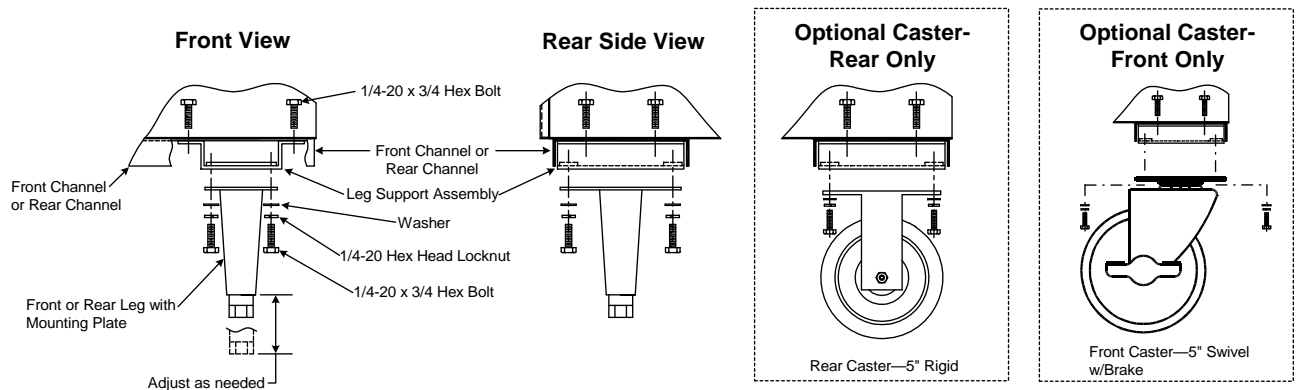

Caster/Leg Installation and Adjustment

⚠ WARNING

Frymaster fryers equipped with legs are for permanent installations. Fryers fitted with legs must be lifted during movement to avoid damage and possible bodily injury. For a moveable or portable installation, Frymaster optional equipment casters must be used.

Questions? Call 1-800-551-8633.

**HIGH EFFICIENCY DECATHLON (HD) SERIES GAS FRYERS
CHAPTER 3: INSTALLATION**

3.4 Gas Connections

 **DANGER**

Before connecting new pipe to this appliance the pipe must be blown out thoroughly to remove all foreign material. Foreign material in the burner and gas controls will cause improper and dangerous operation.

U.S. NATIONAL CODE REQUIREMENTS

This equipment is to be installed in compliance with the Basic Plumbing Code of the Building Officials and Code Administrators International, Inc. (BOCA) and the Food Service Sanitation Manual of the U.S. Food and Drug Administration.

This equipment is manufactured to use the type of gas specified on the rating plate attached to the door. Connect equipment stamped "NAT" only to natural gas and that stamped "PRO" only to LP (Propane) gas.

Installation shall be made with a gas connector that complies with national and local codes. Quick disconnect devices, if used, shall likewise comply with national and local codes.

 **DANGER**

The fryer MUST be connected to the gas supply specified on the rating and serial number plate located on the back of the fryer door.

 **DANGER**

If gas odors are detected, the gas supply MUST be shut off at the main shut-off valve. The local gas company or FASC should be contacted immediately to rectify the problem.

The gas supply (service) line must be the same size or greater than the fryer inlet line. This fryer is equipped with a 3/4" (22 mm) male inlet. The gas supply line must be sized to accommodate all the gas-fired equipment that may be connected to that gas supply. Consult your contractor, gas company, supplier, or other knowledgeable authorities.

Recommended Gas Supply Line Sizes			
Gas Types	Number of Fryers		
	1	2 to 3	4 or more (*)
Natural Gas	3/4" (22 mm)	1" (28 mm)	1 1/4" (35 mm)
Propane (LP) Gas	1/2" (15 mm)	3/4" (22 mm)	1" (28 mm)
(*) When exceeding 18 feet for a configuration of more than four fryers, it is necessary to provide a 1 1/4" (35 mm) rigid gas connection.			

**HIGH EFFICIENCY DECATHLON (HD) SERIES GAS FRYERS
CHAPTER 3: INSTALLATION**

3.4 Gas Connections (cont.)

Gas Supply Type and Pressure	
Gas Supply Type	Gas Supply Pressure
Natural Gas	6-10" W.C. (Dynamic)
Propane (LP) Gas	11-13" W.C. (Dynamic)

 **DANGER**

When pressure-testing incoming gas supply lines, disconnect the fryer from the gas line if the test pressure is ½" PSI [3.45 kPa (14 inches W.C.)] or greater to avoid damage to the fryer's gas piping and gas valve(s).

 **DANGER**

All connections must be sealed with a joint compound suitable for the gas being used and all connections must be tested with a solution of soapy water before lighting any pilots.

Never use matches, candles, or any other ignition source to check for leaks. If gas odors are detected, shut off the gas supply to the appliance at the main shut-off valve and immediately contact the local gas company or an authorized service agency for service.

 **DANGER**

"Dry-firing" your unit will cause damage to the frypot and can cause a fire. Always ensure that melted shortening, cooking oil or water is in the frypot before firing the unit.

- A. Rigid Connections: Check any installer-supplied intake pipe(s) visually and clean threading chips, or any other foreign matter before installing into a service line. If the intake pipes are not clear of all foreign matter, the orifices will clog when gas pressure is applied. Seal pipe joints with a sealant resistive to LP gas. When using thread compound on gas piping, use very small amounts and only on male threads. Use a pipe thread compound that is not affected by the chemical action of LP gases. **DO NOT** apply thread compound to the first two pipe threads—doing so will cause clogging of the burner orifices and control valve.
- B. Manual shut-off valve: This gas service supplier-installed valve must be installed in the gas service line ahead of the fryers in the gas stream and in a position where it can be reached quickly in the event of an emergency.
- C. Regulating Gas Pressure: The fryer and shut-off valve must be disconnected from the gas supply during any pressure testing of the system.

NOTE: External gas regulators are not normally required on this fryer. A safety control valve protects the fryer against pressure fluctuations. If the incoming pressure is in excess of ½" PSI (3.45 kPa/35 mbar), **a step-down regulator is required.**

HIGH EFFICIENCY DECATHLON (HD) SERIES GAS FRYERS

CHAPTER 3: INSTALLATION

3.4 Gas Connections (cont.)

 **DANGER**

When pressure-testing incoming gas supply lines, disconnect the fryer from the gas line if the test pressure is ½" PSI [3.45 kPa (14 inches W.C.)] or greater to avoid damage to the fryer's gas piping and gas valve(s).

- D. Manifold Pressure: Your local service technician should check the manifold pressure with a manometer.
1. Check the rating plate for specific manifold gas pressures. Natural gas units normally require 4" W.C. (10.0 mbar), and propane/LP units normally require 11" W.C. (27.5 mbar) gas pressure.
 2. Confirm that the arrow forged into the bottom of the regulator body, which indicates gas flow direction, is pointed downstream towards the fryers. The air vent cap is also part of the regulator and should not be removed. If a vent line from the gas pressure regulator is used, it should be installed in accordance with local codes or in the absence of local codes, with the National Fuel Gas Code, ANSI Z223.1-(latest edition) in the U.S. and appropriate national or European Community (CE) standards in the European Union.

 **WARNING**

Use a diluted soap solution to find potentially dangerous gas leaks when making new connections.

- E. Regulators can be adjusted in the field, but it is recommended that qualified service personnel adjust a regulator only if it is known to be out of adjustment or serious pressure fluctuations have been found and can not be solved another way.
- F. Only qualified service personnel should make adjustments to the regulators.
- G. Orifices: The fryer can be configured to operate on any available gas. The correct safety control valve, appropriate gas orifices, and pilot burner are installed at the factory. While the valve can be adjusted in the field, only qualified service personnel should make adjustments with proper test equipment.
- H. Flexible Couplings, Connectors and Casters: If the fryer is to be installed with flexible couplings and/or quick-disconnect fittings, the installer must use a heavy-duty AGA design-certified commercial flexible connector of at least ¾" NPT (with suitable strain relief), in compliance with the Standard for Connectors for Movable Gas Appliances, ANSI Z21.69-(latest edition) and Addenda Z21.69a-(latest edition). Quick disconnect devices must comply with the Standard for Quick-Disconnect Devices for Use with Gas Fuel, ANSI Z21.41-(latest edition).
1. For an appliance equipped with casters, the installation in the U.S. shall be made with a connector that complies with Standard for Connectors for Movable Gas Appliances, ANSI Z21.69-(latest edition) and Addenda Z21.69a-(latest edition). In the European Union, use a flexible coupling certified as NF D 36123 (or other national standard) or a quick disconnect device certified NF D 36124 (or other national standard).

3.5 Gas Connections (cont.)

 **WARNING**

Do not attach accessories to this fryer unless fryer is secured from tipping. Personal injury may result.

HIGH EFFICIENCY DECATHLON (HD) SERIES GAS FRYERS

CHAPTER 3: INSTALLATION

2. The fryer must be restrained by means independent of the flexible coupling or connector in order to limit the movement of the fryer. Restraining brackets are located on the back panel of the fryer for the attachment of restraints.
3. If disconnection of the restraint is necessary, this restraint must be reconnected after the fryer has been returned to its originally installed position.
 - I. After hook-up, bleed the gas line of air to ensure that the pilot light will ignite quickly.

AUSTRALIAN REQUIREMENTS

To be installed in accordance with AS 5601 / AG 601, local authority, gas, electricity, and any other relevant statutory regulations.

3.5 Gas Specifications

NON-CE (Altitudes of 2000 feet or less)							
MODEL	INPUT (BTU)	GAS TYPE	ORIFICE (MM)	ORIFICE PART NO.	QTY	EQUIPMENT PRESSURE	
						MBAR	INCH W.C.
D20G	50	NAT LP	2.18(#44) 1.40(#54)	810-2050 810-2324	2	10	4
					2	27.5	11
D50G	85	NAT LP	2.08(#45) 1.32(#55)	14-0067-45 810-2441	4	10	4
					4	27.5	11
D50G(HP)	120	NAT LP	2.53(#39) 1.51(#53)	810-2048 810-2059	4	10	4
					4	27.5	11
D50GDDHP	115	NAT LP	2.44(#41) 1.51(#53)	14-0067-41 810-2059	4	10	4
					4	27.5	11
D60G	112	NAT LP	2.08(#45) 1.32(#55)	14-0067-45 810-2441	5	10	4
					5	27.5	11
D60G(HP)	150	NAT LP	2.53(#39) 1.51(#53)	810-2048 810-2059	5	10	4
					5	27.5	11
D80G	122	NAT LP	2.26(#43) 1.40(#54)	810-2049 810-2324	5	10	4
					5	27.5	11
D80G(HP)	165	NAT LP	2.58(#38) 1.61(#52)	810-2062 810-2063	5	10	4
					5	27.5	11
HD50G	95	NAT LP	2.26(#43) 1.40(#54)	810-2938 810-2939	4	10	4
					4	27.5	10
HD50G Aust	93	NAT LP	2.58 (#38) 1.4(#54)	810-2062 810-2939	4	8.2	3.3
					4	23.9	9.6
HD60G	125	NAT LP	2.26(#43) 1.40(#54)	810-2938 810-2939	5	10	4
					5	27.5	10
HD60G Aust	117	NAT LP	2.58 (#38) 1.4(#54)	810-2062 810-2939	4	8.2	3.3
					4	23.9	9.6

NOTE: Outlet gas pressure must be adjusted strictly within the above requirements 5 to 10 minutes after the appliance is operating. (Pilot Flame Adjustment: Turn the pilot adjustment screw clockwise/counter-clockwise until the desired flame-volume is achieved.)

HIGH EFFICIENCY DECATHLON (HD) SERIES GAS FRYERS

CHAPTER 3: INSTALLATION

3.5 Gas Specifications

CE ONLY (Altitudes of 2000 feet or less)							
MODEL	INPUT (kW)	GAS TYPE	ORIFICE (MM)	ORIFICE PART NO.	QTY	EQUIPMENT PRESSURE	
						MBAR	INCH W.C.
D20G	15,0	G20	2,40	810-2060	2	10,0	4,0
		G25	2,40	810-2060	2	15,0	6,0
		G31	1,51	810-2059	2	27,0	10,8
D50G	30,0	G20	2,40	810-2060	4	10,0	4,0
		G25	2,40	810-2060	4	15,0	6,0
		G31	1,51	810-2059	4	27,0	10,8
D60G	37,5	G20	2,40	810-2060	5	10,0	4,0
		G25	2,40	810-2060	5	15,0	6,0
		G31	1,51	810-2059	5	27,0	10,8
D80G	37,5	G20	2,40	810-2060	5	10,0	4,0
		G25	2,40	810-2060	5	15,0	6,0
		G31	1,51	810-2059	5	27,0	10,8
HD50 Series	27,0	G20	2,20	810-3132	4	10,0	4,0
		G25	2,20	810-3132	4	15,0	6,0
		G31	1,40	810-2939	4	23,9	10,8
HD60 Series	33,7	G20	2,20	810-3132	5	10,0	4,0
		G25	2,20	810-3132	5	15,0	6,0
		G31	1,40	810-2939	5	23,9	10,8
HD80 Series	33,7	G20	2,20	810-3132	5	10,0	4,0
		G25	2,20	810-3132	5	15,0	6,0
		G31	1,40	810-2939	5	23,9	10,8
LHD65 Series	30,2	G20	2,20	810-3132	5	10,0	4,0
		G25	2,20	810-3132	5	15,0	6,0
		G31	1,40	810-2939	5	23,9	10,8
FPLHD65 Series	30,2	G20	2,20	810-3132	5	10,0	4,0
		G25	2,20	810-3132	5	15,0	6,0
		G31	1,40	810-2939	5	23,9	10,8

NOTE: Outlet gas pressure must be adjusted strictly within the above requirements 5 to 10 minutes after the appliance is operating. (Pilot Flame Adjustment: Turn the pilot adjustment screw clockwise/counter-clockwise until the desired flame-volume is achieved.)

3.6 Gas Conversion Procedures

DANGER

This appliance was configured at the factory for a specific type of gas. Converting from one gas type to another requires the installation of specific gas-conversion components.

Switching to a different type of gas without installing the proper conversion components may result in fire. NEVER ATTACH THIS APPLIANCE TO A GAS SUPPLY FOR WHICH IT IS NOT CONFIGURED!

Conversion of this appliance from one type of gas to another should only be performed by qualified, licensed, and authorized installation or service personnel, as defined in Section 1.6 of this manual.

Contact factory with the following information when performing conversions:

- Fryer Serial Number • Gas Type
- Fryer Model Number • Operating Altitude

Conversions can only be executed by qualified, factory-authorized personnel.

HIGH EFFICIENCY DECATHLON (HD) SERIES GAS FRYERS

CHAPTER 3: INSTALLATION



Typical non-CE gas valve for electronic-ignition equipped fryers.

3.7 Electrical Connections

The fryer when installed must be electrically grounded in accordance with local codes, or in the absence of local codes, with the National Electrical Code, ANSI/NFPA 70-(latest edition).

DANGER

This fryer is equipped with a three-prong (grounding) plug for protection against electrical shock and must be plugged directly into a properly grounded, three-prong receptacle. DO NOT CUT, REMOVE, OR OTHERWISE BYPASS THE GROUNDING PRONG ON THIS PLUG!

The rating plate and wiring diagram are located inside the front door. The fryer is equipped with a 120VAC single-phase 60-hertz system (Domestic), or 230VAC single-phase 50-hertz system (International/CE). Do not cut or remove the ground prong from the power cord plug. Do not attempt to use the fryer during a power outage.

DANGER

This appliance requires electrical power for operation. Place the gas control valve in the OFF position in case of a prolonged power outage. Do not attempt to operate this appliance during a power outage.

DECATHLON (D & HD) SERIES GAS FRYERS

CHAPTER 4: FRYER OPERATIONS

4.1 Initial Start-up

WARNING

The on-site supervisor is responsible for ensuring that operators are made aware of the inherent hazards of operating a hot oil frying system, particularly the aspects of system operation, oil filtration, draining and cleaning procedures.

Cleaning: New units are wiped clean with solvents at the factory to remove any visible signs of dirt, oil, or grease remaining from the manufacturing process, and then coated lightly with oil. Before any food preparation, wash thoroughly with hot, soapy water to remove any film residue and dust or debris then rinse out and wipe dry. Also wash any accessories shipped with the unit. Close the drain valve completely and remove the crumb screen covering the heating tubes. Ensure the screws holding the thermostat and high-limit control sensing bulbs into the frypot are tight.

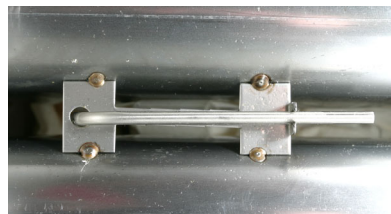

Typical high-limit/sensor probe locations and mounting hardware.

WARNING

Do not bang fry baskets or other utensils on the fryer's joiner strip. The strip is present to seal the joint between the frypot. Banging fry baskets on the strip to dislodge shortening will distort the strip, adversely affecting its fit. It is designed for a tight fit and should only be removed for cleaning.

DANGER

Never operate this appliance with an empty frypot. The frypot must be filled with water or cooking oil/shortening before lighting the burners. Failure to do so will damage the frypot and may cause a fire.

WARNING

When checking for burner ignition or performance, do not get too close to the burners. Slow ignition can cause possible flashback, increasing the potential for facial and body burns.

HIGH EFFICIENCY DECATHLON (HD) SERIES GAS FRYERS

CHAPTER 4: FRYER OPERATIONS

4.1.1 Pilot Lighting Procedures, Standing Pilot Only

Initial Pilot Lighting: All Frymaster fryers are tested, adjusted and calibrated to sea level conditions before leaving the factory. Adjustments to assure proper operation of pilot may be necessary on installation to meet local conditions, low gas pressure, differences in altitude and variations in gas characteristics. These adjustments correct possible problems caused by rough handling or vibration during shipment, and are to be performed only by qualified service personnel. These adjustments are the responsibility of the customer and/or the dealer and are not covered by the Frymaster warranty.

The inlet pipe at the lower rear of the fryer brings incoming gas to the pilot safety control valve, then to the pilot and main burners. The pilot is located high in the cabinet center, at the base of the frypot.

Light the pilot as follows:

1. Turn off the manual shut-off valve on the incoming service line.
2. Turn the operating thermostat or the computer off.
3. Depress the pilot gas cock dial on the combination control valve and turn to "OFF".
4. Wait approximately 5 minutes for accumulated gas to disperse.

Note: Inspect high-limit thermostat/temperature probe location prior to filling frypot with water or oil. Ensure that connecting hardware is intact and bulbs are properly attached.

5. Fill the frypot with oil or water to the bottom OIL LEVEL line scribed on the frypot back. Ensure that heating tubes are covered in liquid prior to engaging burners.
6. Open the manual shut-off valve on the incoming service line.
7. Apply lighted match or taper to the pilot burner head.
8. Turn the gas cock dial on the control valve to "Pilot", then depress and hold the dial until the pilot stays lit for approximately 1 minute after the flame appears on the pilot. Release the knob. The pilot should remain lit.

Piezo Ignitor: Turn the gas cock dial on the control valve to "Pilot", and then repeatedly press the piezo ignitor button while depressing the gas valve knob until the pilot lights. Continue to hold the knob in for 1 minute. Release the knob. The pilot should remain lit.



9. If the pilot fails to stay lit, depress the dial and re-light the pilot, depressing the dial longer before releasing.
10. When the pilot stays lit, turn the gas cock dial to "ON".
11. Turn the operating thermostat, computer or controller on, and then ensure the main burners ignite from the pilot.

HIGH EFFICIENCY DECATHLON (HD) SERIES GAS FRYERS

CHAPTER 4: FRYER OPERATIONS

4.1.2 Pilot Lighting Procedures, Electronic Ignition Systems

 **WARNING**

Never use a match or taper to light pilot on this ignition system.

1. Turn gas "ON".
2. Turn electric power "ON" with the appropriate rocker switch or controller/computer.
3. The ignition module will energize the pilot gas supply and the igniter. The igniter spark will ignite the pilot gas. The presence of the pilot flame is then proved by a flame sensor, which sends a signal to the main gas supply, opening the valve. The operating thermostat or computer/controller controls the fryer after ignition.

 **WARNING**

In the event of prolonged power failure, the ignition module will shut down and lock out the system. Turn the unit power "OFF" and then back "ON" after power has been re-established.

4. If the pilot flame fails, the ignition module will shut down and lock out the system. To restart, turn the electric power "OFF", wait approximately 5 minutes for the system to recycle itself, and then turn the power "ON" again. Repeat Steps 1-3.

4.2 Boil-Out Procedure

 **DANGER**

Never leave the fryer unattended during the boil-out process. If the boil-out solution boils over, turn the fryer off immediately and let the solution cool for a few minutes before resuming the process. To lessen the chance of boil over, turn the fryer's gas valve knob to the PILOT position occasionally.

 **WARNING**

Do not drain boil-out solution into a shortening disposal unit, a built-in filtration unit, or a portable filter unit. These units are not intended for this purpose and will be damaged by the solution.

 **DANGER**

Remove all drops of water from the frypot before filling with cooking oil or shortening. Failure to do so will cause spattering of hot liquid when the oil or shortening is heated to cooking temperature and may cause injury to nearby personnel.

HIGH EFFICIENCY DECATHLON (HD) SERIES GAS FRYERS
CHAPTER 4: FRYER OPERATIONS

4.2 Boil-Out Procedure (cont.)

- A. Pour cleaning solution into the frypot and add water to the bottom OIL LEVEL line scribed in the back of the frypot.
- B. Operating thermostat-equipped fryers: Set dial/temperature controller to 225°F (107°C), just above that of boiling water.
- C. Filtration/Boil-Mode equipped fryers: Turn fryer power switch to "ON". Press the fryer-reset switch (if applicable). Turn the boil-out switch "ON".

 **CAUTION**

If the pilot and main burner go out, the fryer(s) MUST be left completely shut down at least 5 minutes before lighting.

- D. The main burner will ignite.
- E. When the solution nears boiling point, reset the temperature controller to 200° (93°C).
- F. The burners should shut off just as the water starts to boil.

 **CAUTION**

Do not leave fryer unattended. The boil-out solution may foam and overflow if fryer is left unattended. Press ON/OFF switch to the "OFF" position (Filtration/Boil-Mode equipped fryers) or reduce temperature (Operating Thermostat equipped fryers) to control this condition.

- G. The burners will heat the boil-out solution to a simmer. Simmer the solution for approximately 45 minutes. Wearing protective gloves, scrub the sides of the frypot and the tubes with the L-shaped Teflon brush, being careful not to disturb the temperature sensing probes and the high-limit thermostat.
- H. Do not allow the water level to decrease below the bottom OIL LEVEL line in frypot during boil-out operation.

 **WARNING**

Water or boil-out solution MUST not be allowed to drain into the filter pan or filter system. Irreversible damage will result if water is allowed into the system.

- I. Operating Thermostat equipped fryers: After boil out is complete, turn the thermostat dial to "OFF". Filtration/Boil-Mode equipped fryers: After boil out is complete, turn the boil-out and fryer switches to "OFF". Drain the solution from the frypot. Place a metal stockpot of sufficient size to safely hold the entire contents of the frypot under the drain port to collect the water/boil-out solution. Do not allow water or boil-out solution to drain into the filter pan. The filter pump is not designed for water operation, and will be irreparably damaged (see warning statement above).

HIGH EFFICIENCY DECATHLON (HD) SERIES GAS FRYERS
CHAPTER 4: FRYER OPERATIONS

4.2 Boil-Out Procedure (cont.)

- J. Close the drain, add fresh water (without boil-out solution) and wash all surfaces of the frypot. Drain again.
- K. Refill the frypot with fresh water and vinegar to neutralize any residual boil-out solution. Wash all surfaces of the frypot. Drain completely and wipe down all surfaces of the frypot to completely remove all water.

Computer-equipped fryers: See computer manual for boil-out programming and follow the above procedures for boil-out.

 **DANGER**

Do not go near the area directly over the flue outlet while the fryer is operating.

Always wear oil-proof, insulated gloves when working with the fryer filled with hot oil.

Always drain hot oil into a metal stockpot of sufficient size to safely hold the entire contents of the frypot.

4.3 Final Preparation

 **WARNING**

NEVER set a complete block of solid shortening on top of heating tubes. To do so will damage the heating tubes and frypot and void the warranty.

- A. When using a liquid shortening, fill the fryer to the bottom OIL LEVEL line scribed into the back of the frypot. The top oil level line is the maximum oil level line and the low oil level line is the minimum oil level line.
- B. When using a solid shortening, first melt it in a suitable container, or cut it into small pieces and pack it below the heat tubes, between the tubes and on top of the tubes, leaving no air spaces around the tubes. Do not disturb or bend the sensing bulbs.
- C. Electronic Thermostat Controller with Melt Cycle Option Enabled: Set the controller to the working temperature. The burners will cycle on approximately 5 seconds, and off for approximately 15 seconds until the temperature reaches 150°F (66°C). The electronic thermostat will then switch to normal operation.

HIGH EFFICIENCY DECATHLON (HD) SERIES GAS FRYERS
CHAPTER 4: FRYER OPERATIONS

4.3 Final Preparation (cont.)

- D. Operating Thermostat: Turn the burners "ON" for about 10 seconds, "OFF" for a minute, etc., until the shortening is melted. If you see smoke coming from the shortening while melting this way, shorten the "ON" cycle and lengthen the "OFF" cycle. Smoke indicates potential scorching of the shortening, which will shorten its useful life.
- E. Compu-Fry Computer: Press the computer on/off switch to "ON". The burners will initially operate in the MELT CYCLE mode until the shortening reaches 180°F. It will then automatically switch to normal operation.
- F. When the frypot is filled and the shortening is melted, carefully replace the crumb screen over the heat tubes. Wear oil-proof insulated gloves to avoid the potential for burn injury when placing crumb screen in frypot.
- G. Before starting operation, set the electronic thermostat/operating thermostat or program the computer to the probable working temperature and wait for the temperature to stabilize.

For additional computer operational procedures, see controller manual that shipped with the fryer.

DECATHLON (D & HD) SERIES GAS FRYERS

CHAPTER 5: CONTROLLER OPERATING INSTRUCTIONS

5.1 Operating Instructions: Electronic Thermostat Controller

Decathlon Series gas fryers come standard with an electronic thermostat controller, which incorporates a temperature-control circuit board, a potentiometer, and a temperature probe. The potentiometer knob is turned to the desired temperature setting, similar to a standard thermostat. Various switch options for the controller are available, based on fryer options at the time of order. Typical switch options are illustrated below.

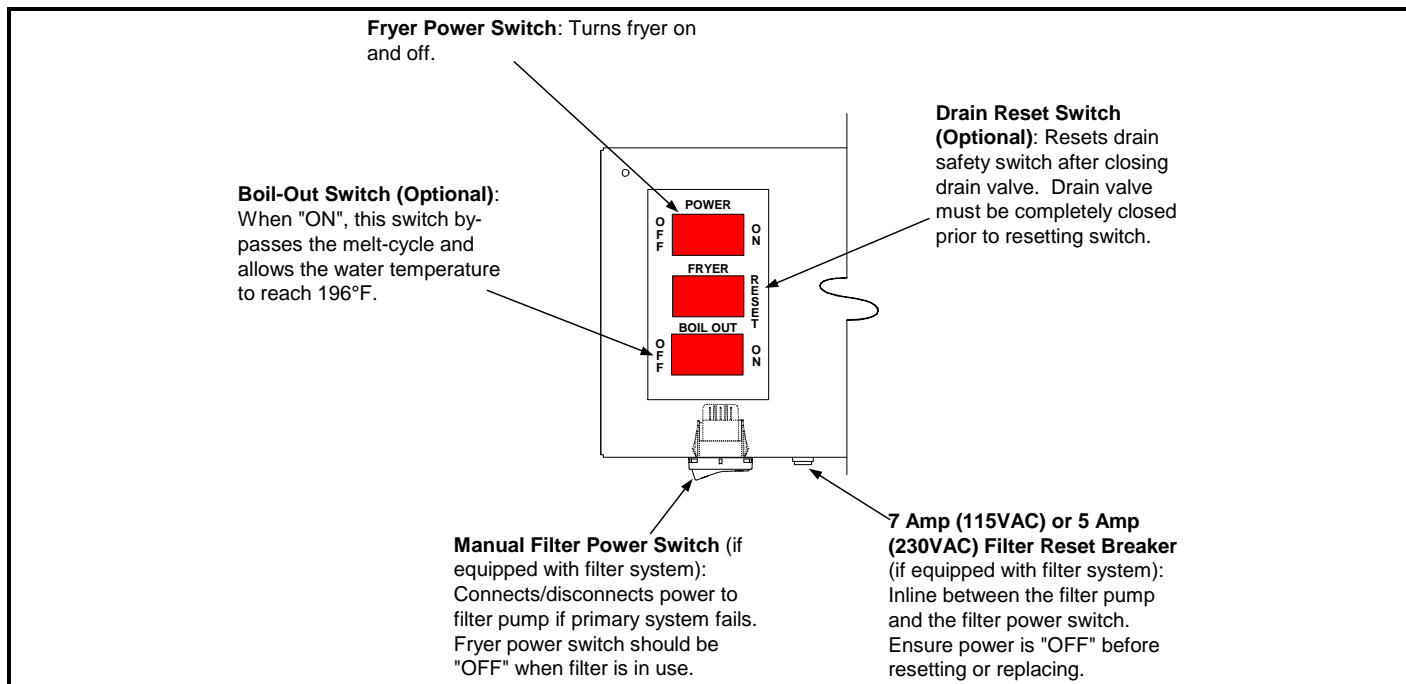

Electronic thermostat controller with power switch and boil-out option.

HIGH EFFICIENCY DECATHLON (HD) SERIES GAS FRYERS

CHAPTER 5: CONTROLLER OPERATING INSTRUCTIONS

5.1 Operating Instructions: Electronic Thermostat Controller (cont.)

FRYER POWER SWITCH – This switch turns the fryer on and off. When the power switch is in the "ON" position, the indicator light will be lit when calling for heat.

BOIL-OUT SWITCH (Optional) – When the boil-out switch is "ON", it will bypass the electronic thermostat melt-cycle, and allow the water temperature to reach approximately 196°F (91°C).

DRAIN RESET SWITCH (Optional) – Resets drain safety switch after draining the fryer. Drain valve must be closed completely before resetting switch.

MANUAL FILTER POWER SWITCH (if equipped with filter system) – Controls power to the filter pump in the event the primary system fails. **Fryer Power Switch should be in "OFF" position when in use.**

FILTER RESET BREAKER (7 Amp Circuit Breaker- 120VAC or 5 Amp Circuit Breaker- 230VAC) – the breaker is inline between the filter switch and the pump. Ensure filter power is off prior to resetting or replacing.

5 AMP (115VAC) or 2 AMP (230VAC) FUSE – each fryer circuit is protected by a 5 amp (115VAC) or 2 amp (230VAC) fuse located under the control panel.

5.2 Electronic Thermostat Controller/Computer

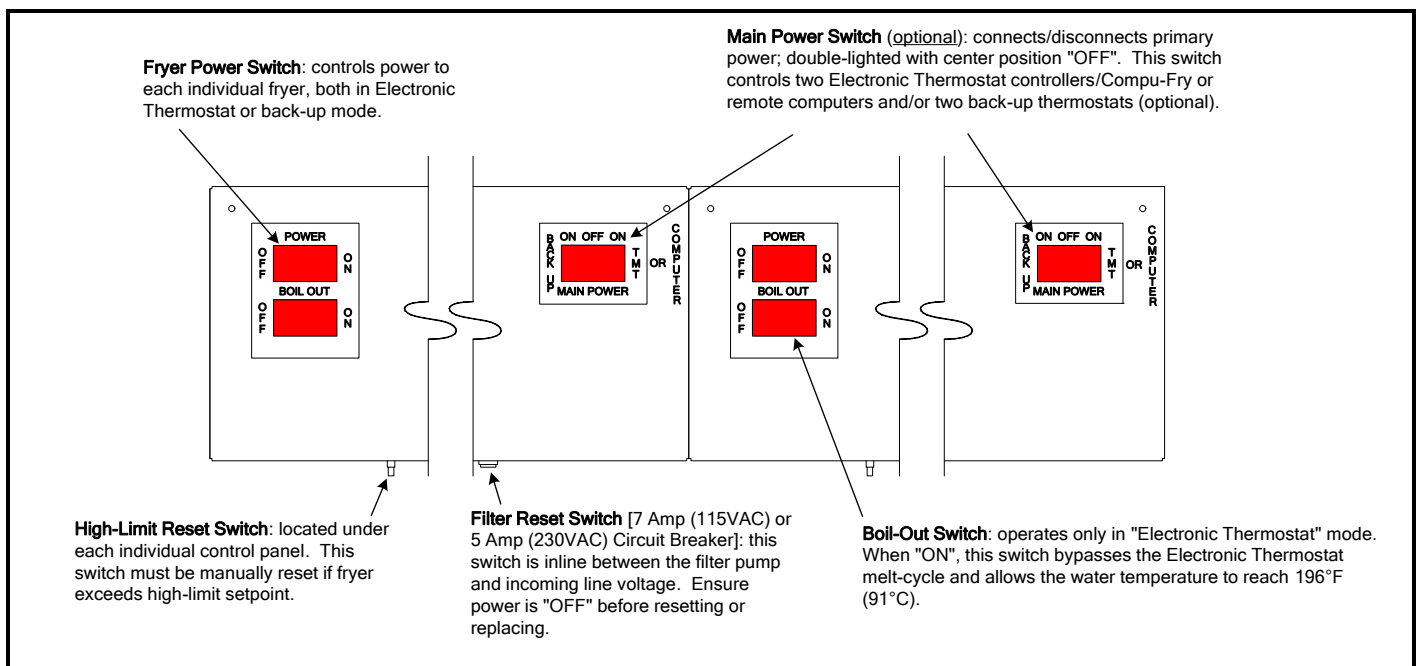

HIGH EFFICIENCY DECATHLON (HD) SERIES GAS FRYERS
CHAPTER 5: CONTROLLER OPERATING INSTRUCTIONS

5.2 Electronic Thermostat Controller/Computer (cont.)

MAIN POWER SWITCH – connects/disconnects primary power; double-lighted with center position "OFF". One main switch controls two electronic thermostats/Compu-Fry or remote computers. When the main power switch is in the center position, power is removed from the two fryers controlled by the electronic thermostats/Compu-Fry or remote computers. When the main power switch is pressed to the right, power is supplied to the electronic thermostat/Compu-Fry or remote computer of each fryer.

INDIVIDUAL FRYER POWER SWITCH – this switch controls power to the individual fryer. When the power switch is in the "ON" position, the indicator light will be lighted when calling for heat. The power switch only removes power from the temperature control circuit (electronic thermostat controller). The power switch should be in the "OFF" position during filtering.

BOIL-OUT SWITCH – **operates only when the electronic thermostat controller is enabled.** When the boil-out switch is "ON", it will bypass the melt cycle, and allow the water temperature to reach approximately 196°F (91°C).

HIGH-LIMIT RESET – this reset button is located under each individual control panel, and must be manually reset if the fryer exceeds high-limit setpoint.

FILTER RESET BREAKER (7 amp circuit breaker- 120VAC, or 5 amp circuit breaker- 230VAC) – the breaker is in line between the filter switch and the pump. Ensure filter power is off prior to resetting or replacing.

5 AMP (115VAC) or 2 AMP (230VAC) FUSE – each fryer circuit is protected by a 5 amp (115VAC) or 2 amp (230VAC) fuse located under the control panel.

DECATHLON (D & HD) SERIES GAS FRYERS

CHAPTER 6: FILTRATION

WARNING

Drawings and photos used in this manual are intended to illustrate operational, cleaning and technical procedures and may not conform to on-site management operational procedures.

6.1 General

Most SUFF/UFF systems use filter paper as the filter medium. Some filter systems can be special ordered with a filter-leaf assembly, which eliminates the need for filter paper. Both types require the use of filter powder to enhance the filtration process. Photos used in the procedural illustrations may or may not resemble the filter unit that came with the frying system. The following procedures apply to all fryers equipped with SUFF/UFF filter systems. Filter system design depends on the frying system configuration (single or multi-battered systems- see photos below).

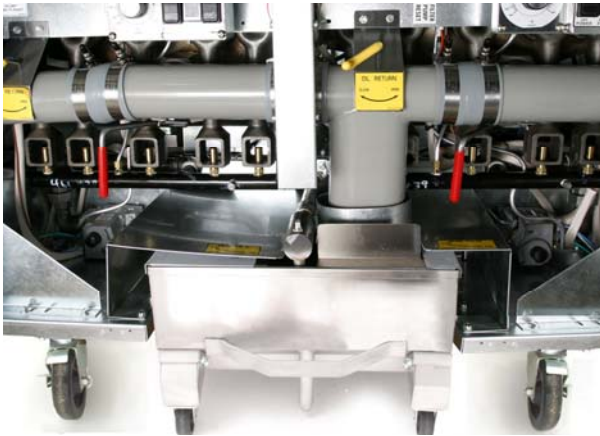

Typical Under Fryer Filter (UFF) installed in a multi-battered frying system.

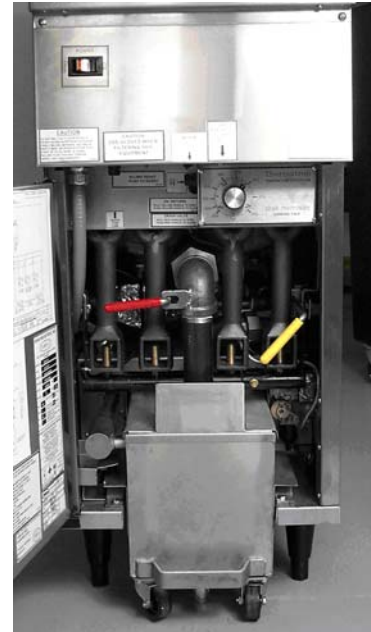

Typical Single Under Fryer Filter (SUFF) installed in a single fryer.

DECATHLON (D & HD) SERIES GAS FRYERS

CHAPTER 6: INSTALLATION AND OPERATION

6.2 Filter Preparation

On initial installation and before each use, clean the filter:

- a. remove all loose parts from the filter,
- b. wash the filter pan and all accessories in hot, soapy water,
- c. and dry thoroughly.

6.2.1 Filter Unit Types

FILTER PAPER AND HOLD DOWN RING

Filter paper is held in place by a hold-down ring. Oil moves through the paper, leaving behind impurities.

1. Filter pan.
2. Filter support grid.
3. Filter paper.
4. Hold-down ring.
5. Crumb screen.
6. Filter pan lid.

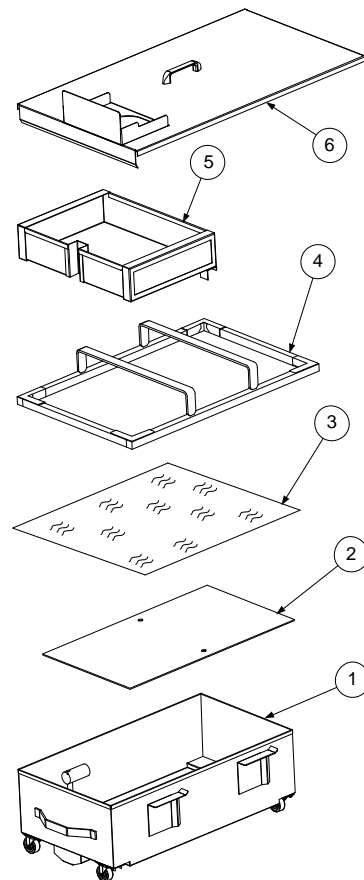

A filter unit which utilizes disposable filter paper to filter oil.

DECATHLON (D & HD) SERIES GAS FRYERS CHAPTER 6: INSTALLATION AND OPERATION

6.2.1 Filter Unit Types (cont.)

FILTER LEAF

A filter leaf is a fine mesh screen which is reusable and takes the place of disposable paper. Oil moves through the leaf, leaving behind impurities.

1. Filter pan.
2. Filter leaf.
3. Crumb Screen.
4. Filter pan lid.
5. Caster.

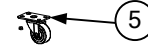
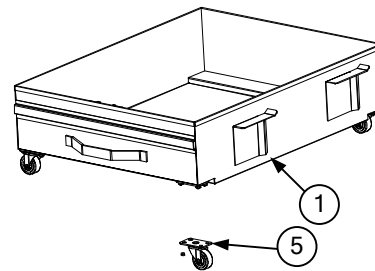
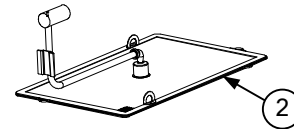
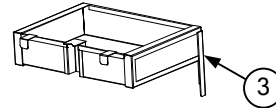
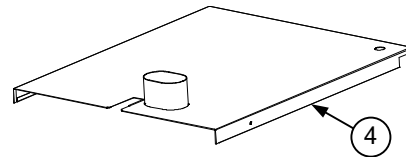

A filter unit which utilizes a filter leaf to filter the oil.

DECATHLON (D & HD) SERIES GAS FRYERS

CHAPTER 6: INSTALLATION AND OPERATION

6.2.2 Assembling the Filter

FILTER PAPER AND HOLD DOWN RING

1. Place the support grid in the bottom of filter pan.



Support grid properly placed in filter pan.

2. Put one filter paper sheet on top of the support grid. Be sure the paper covers the filter pan bottom and laps two inches onto the pan wall.



Ensure filter paper overlaps two inches on all sides and is evenly distributed under the hold-down ring.

3. Position the hold-down ring on top of the filter paper. Ensure the hold-down ring seals around the support grid. This prevents air from getting into the system.

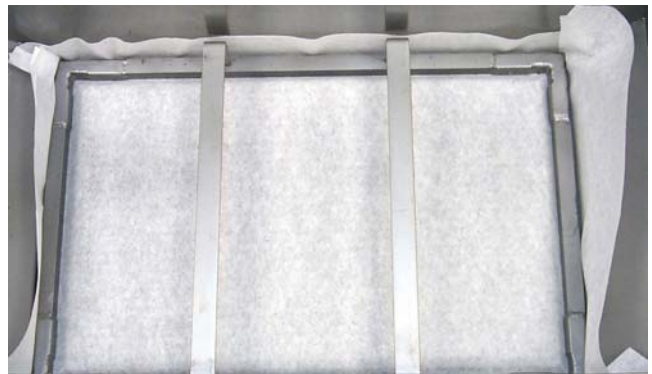

Hold-down ring positioned correctly over filter paper in filter pan.

DECATHLON (D & HD) SERIES GAS FRYERS CHAPTER 6: INSTALLATION AND OPERATION

6.2.2 Assembling the Filter (cont.)

4. Sprinkle 8 ounces (227g) of filter powder on the filter sheet. Ensure the powder covers the filter paper evenly.



Sprinkle the proper amount of filter powder evenly over the paper.

5. Place the crumb screen in the filter pan. Allow the crumb screen to rest on the top edges of the hold-down ring.



Crumb screen properly placed.

6. Place filter pan cover onto the filter pan assembly. Ensure the pickup tube is properly positioned in the pan lid access hole.



Fully assembled pan with pickup tube properly positioned in pan lid access hole. Position may vary between models.

DECATHLON (D & HD) SERIES GAS FRYERS CHAPTER 6: INSTALLATION AND OPERATION

6.2.2 Assembling the Filter (cont.)

FILTER LEAF

1. Remove the filter pan from the fryer by pulling out on the filter pan handle.
2. Remove the filter pan lid picking it up off of the pan.

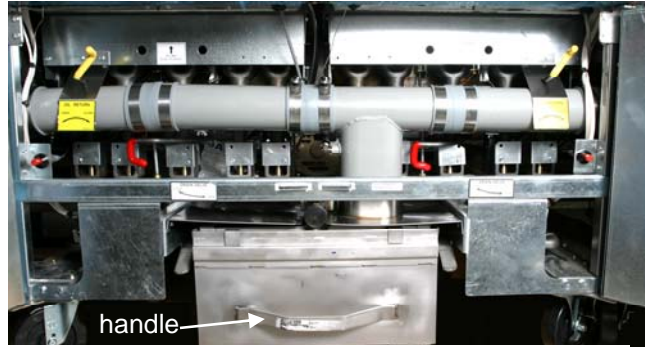

Pull out on the handle to remove the filter pan.

3. Remove the crumb basket by lifting it up and out of the filter pan. Be careful not to damage the tubes or connectors in the pan.



Remove the crumb screen by lifting it up and out.

4. Remove the filter leaf by lifting up on the pickup tube and raising the filter leaf assembly gently out of the filter pan.
5. Clean the filter leaf assembly, crumb screen, and pan with warm soapy water. Thoroughly rinse and dry.
6. When it is clean, place the filter leaf carefully back into the filter pan.



Carefully remove the filter leaf assembly.

DECATHLON (D & HD) SERIES GAS FRYERS CHAPTER 6: INSTALLATION AND OPERATION

6.2.2 Assembling the Filter (cont.)

7. Sprinkle 8 ounces (227g) of filter powder on the filter leaf. Ensure the powder covers the mesh evenly.



Applying filter powder to filter-leaf.

8. Replace the crumb tray in the pan after filter powder application.



Crumb screen properly placed in filter pan.

9. Replace the pan lid. Ensure the pickup tube is properly positioned in the pan lid access hole.



Fully assembled pan with pickup tube properly positioned in pan lid access hole. Position may vary between models.

DECATHLON (D & HD) SERIES GAS FRYERS CHAPTER 6: INSTALLATION AND OPERATION

6.2.3 Installing the Filter

- Slide the filter inside the fryer cabinet. Ensure the male-female pickup tubes are fully engaged. Ensure the filter pan opening is directly under the center dump tube.

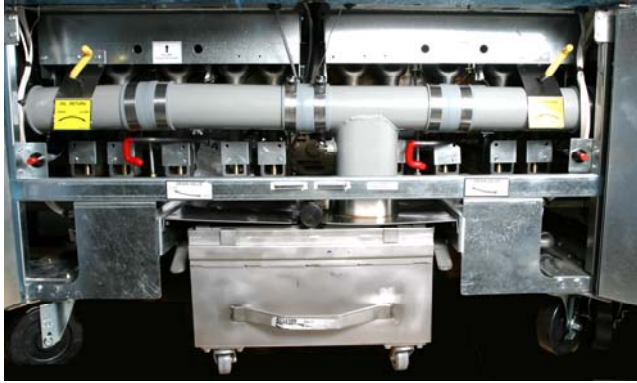

The filter pan slides under the fryer (left), connecting with a male connector (right). Ensure that the pickup tube is securely coupled with this connector. Its location may vary based on model.



6.3 Daily Filter Operation

WARNING

Use caution and wear proper protective clothing. The oil to be filtered is at or near 350°F (177°C). Ensure all hoses are connected properly and drain handles are in their proper position prior to operating any switches or valves. Failure to do this can result in severe burns.

WARNING

Drawings and photos used in this manual are intended to illustrate operational, cleaning and technical procedures and may not conform to on-site management operational procedures.

6.3.1 General Overview

Only filter oil at operating temperature (~350°F/~177°C). When filtering begins, the filter motor engages and oil is drawn through filter paper or a filter-leaf assembly and pumped back into the frypot through oil return plumbing or an optional filter wand. The frypot's drain remains open during the filtering process, allowing oil to filter through the frypot and back into the filter unit. Allow the oil to cycle through this process for approximately 5 minutes. At the end of 5 minutes, close the drain valve and allow the frypot to fill to the top OIL LEVEL line. Leave the pump running for 10-15 seconds after bubbles appear in the frypot or the optional wand sputters to ensure all oil is pumped from the drain pan and the lines. Close the oil return valve and, if an optional filter wand is used, press the wand toggle switch to OFF position.

DECATHLON (D & HD) SERIES GAS FRYERS

CHAPTER 6: INSTALLATION AND OPERATION

6.3.2 Filtering Tools

Assemble tools to be used for filtering. These are supplied with the filter starter kit included with the fryer/filter system:

- Frypot/Filter Brush - used to clean frypot and filter pan sides and bottom, heating elements, and to dislodge sediment during filtration or oil change.
- Clean-out Rod (design may vary) - used to dislodge heavy debris in the drain tube (when needed).
- Filter Powder.
- Filter Paper (not used in filter-leaf equipped filter systems).

The following tools are not required, but are recommended to make the filtering task easier.

- Measuring Cup - used to measure filter powder.
- Stainless Steel Crumb Scoop - for removing large debris from oil prior to filtering.

Note: Always wear oil-resistant, insulated gloves and/or protective gear when working with hot oil.

DECATHLON (D & HD) SERIES GAS FRYERS

CHAPTER 6: INSTALLATION AND OPERATION

6.4 Operating the Filter

6.4.1 Pan Preparation and Operation

See Section 6.2.1, *Assembling the Filter*, and Section 6.2.2, *Installing the Filter*, for the appropriate filter preparation procedure. For optional filter hose and wand, see Section 6.4.3, *Optional Filter Hose and Wand Operation*.

⚠ CAUTION

NEVER operate the filter unit unless cooking oil is at operating temperature (~350°F/ ~177°C).

1. Ensure the filter pan assembly is prepared as described in Section 6.2.1, *Assembling the Filter*, and ensure fryer is turned off.
2. Remove fry baskets from frypot and skim any large debris from the oil. Use extreme caution, as oil is at or near operating temperature (~350°F/~177°C).



Prior to filtering, skim any large debris from oil in frypot.

3. Remove the support grid from the frypot using the clean-out rod. Stir the oil with the frypot/filter brush to suspend debris prior to draining.



Removing support grid from fry vessel prior to filtering.

DECATHLON (D & HD) SERIES GAS FRYERS CHAPTER 6: INSTALLATION AND OPERATION

6.4.1 Pan Preparation and Operation (cont.)

4. After ensuring the filter pan is correctly positioned under the drain tubes, move the red handle to the open position (right) to drain the frypot into the filter pan. **Drain ONLY one frypot at a time. The filter pan is designed to hold the contents of one frypot only.**



Move the red drain valve handle into the open position.

5. After all oil has drained from the frypot into the filter pan, pull the yellow handle to open the oil return lines and activate the filter pump. Leave the red handle in the open position.



Pull the yellow handle to open the oil return valve and activate the filter pump.

Note: A drain-flush option is available on some 3-battery and larger frying systems, according to model. The drain-flush prevents sediment from clogging the drain line in multi-battered systems. After draining the third (or fourth) frypot, close the drain valve (red handle) to all frypots. Ensure all other valves (red and yellow handles) are closed. Pull the blue handle to open the flush valve. After the drain line is clear of sediment (approximately 2 minutes), push the blue handle to close flush valve. Re-open the drain valve (red handle) on the drained frypot and continue with Step 5.

DECATHLON (D & HD) SERIES GAS FRYERS CHAPTER 6: INSTALLATION AND OPERATION

6.4.2 Filter Operation

- Oil will begin to pump from the filter pan into the frypot. If the frypot tubes, sides and bottom have sediment deposits, clean the frypot with the cleaning brush included with the fryer. Clean beneath and under the burner tubes, using care not to disturb the probes (arrow).

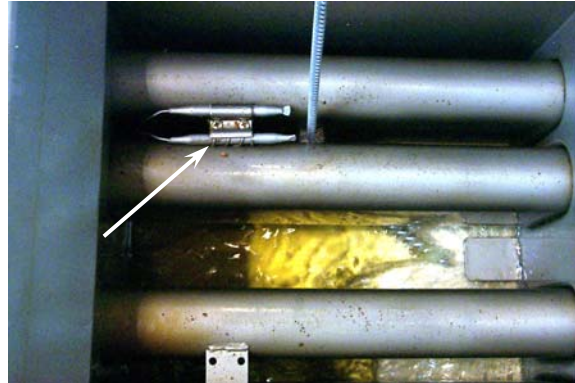

Clean all sediment and suspended particles from the burner tubes and frypot as the oil begins to circulate. Use care not to disturb the probes (arrow) on the burner tube.

- Allow the oil to circulate for approximately 5 minutes (process known as "polishing") to remove suspended particles.

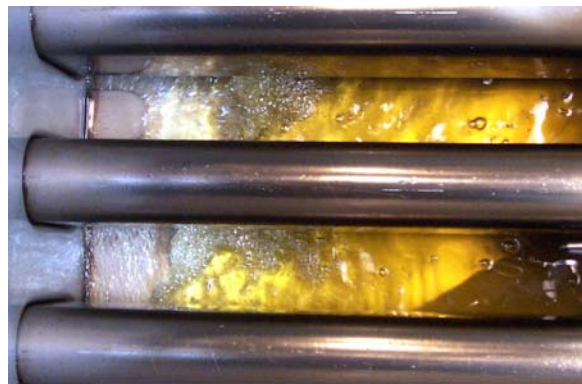

Polishing the oil removes suspended particles, which increases the life of the oil.

- After the filter cycle is complete, close the drain valve (push the red handle to the left until it stops) and allow the fryer to refill (see Step 4 above for additional reference).



After filtering is complete, close the red drain handle to start refilling the frypot.

DECATHLON (D & HD) SERIES GAS FRYERS CHAPTER 6: INSTALLATION AND OPERATION

6.4.2 Filter Operation (cont.)

9. After all oil is pumped back into the frypot, bubbles will form, indicating air in the oil return lines. Allow the oil to bubble for 10-15 seconds to ensure all oil is evacuated from the return lines. Push the yellow handle to close the oil return valve and deactivate the filter pump (see Step 5 above for additional reference).



Allow the oil to bubble for 10-15 seconds to ensure evacuation of all oil in the return lines.

10. If the oil level is low, add oil until the level is at the top OIL LEVEL line.

DO NOT OVERFILL THE FYPOT. This will cause oil to splash out of the frypot during cooking and may cause burns or damage.



Add oil/shortening until the oil level is at the top OIL LEVEL line. DO NOT OVERFILL THE FRYPOT.

11. Replace the frypot grid, using care not to splash hot oil. Turn the fryer on.



Replace the frypot grid, using care not to splash hot oil.

DECATHLON SERIES GAS FRYERS
CHAPTER 5: UNDER FRYER FILTER (SUFF/UFF) FILTRATION

6.4.2 Filter Operation (cont.)

12. Do not allow crumbs to accumulate in the crumb tray. The crumb tray **MUST** be emptied into a fireproof container at the end of frying operations **EACH DAY** (see DANGER statement below).



Empty the filter pan crumb tray into a fire-proof container at the end of frying operations each day. **DO NOT ALLOW CRUMBS TO ACCUMULATE IN TRAY.**

⚠ DANGER

The crumb tray in fryers equipped with a filter system must be emptied into a fireproof container at the end of frying operations each day. Some food particles can spontaneously combust if left soaking in certain shortening material.

⚠ WARNING

Do not bang fry baskets or other utensils on the fryer's joiner strip. The strip is present to seal the joint between the fry vessels. Banging fry baskets on the strip to dislodge shortening will distort the strip, adversely affecting its fit. It is designed for a tight fit and should only be removed for cleaning.

DECATHLON (D & HD) SERIES GAS FRYERS

CHAPTER 6: INSTALLATION AND OPERATION

6.4.3 Optional Filter Hose and Wand Operation

Some frying systems come equipped with an optional filter hose, wand, and toggle switch to facilitate the removal of debris from the frypot. The hose attaches to a no quick-disconnect on the bottom front of the fryer and is controlled using a toggle switch on the fryer control panel.

1. Ensure the oil is at operating temperature (~350°F/~177°C). Turn the fryer off and open the fryer drain valve. Allow the oil to drain into the filter pan.



Moving the red drain valve handle to open the drain valve, allowing hot oil to drain into the filter pan.

2. When all the oil has drained from the frypot, connect the hose/wand assembly to the quick-disconnect on the front bottom of the fryer cabinet. Ensure the hose is properly connected before proceeding.



Optional hose/wand disconnect properly connected to disconnect valve in fryer cabinet.

3. Place the wand into the open frypot and activate the filter with the wand/disposal switch (rocker switch) on the front of the cabinet.

DO NOT PROCEED UNLESS THE WAND IS INSIDE THE FRYPOT. Hot oil can immediately flow from the wand when it is attached, causing burns if the wand is not in the frypot.



After the wand end is properly positioned inside the appropriate frypot, activate the filter pump with the wand/ disposal switch located on the front of the fryer.

DECATHLON (D & HD) SERIES GAS FRYERS CHAPTER 6: INSTALLATION AND OPERATION

6.4.3 Hose and Wand Operation (cont.)

- The oil will start to flow immediately into the frypot. **Keep the wand inside the frypot at all times while the filter pump is activated.**

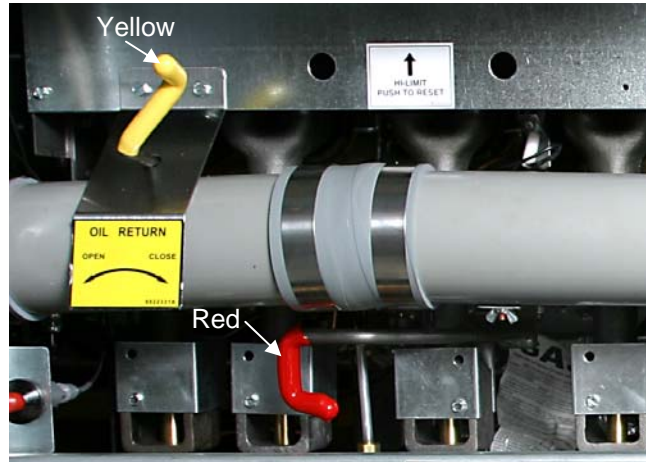

The red handle is attached to the drain valve. The yellow handle is attached to the oil return valve.

- Rinse debris from the frypot into the filter pan with the wand. When cleanup is complete, close the drain valve (red handle) and press the wand/disposal switch to OFF. Allow hose/wand to drain into the filter pan.
- Disconnect the hose/wand from the fryer.



Use the optional wand to rinse debris from the frypot into the filter pan. Maintain a firm grip on the wand handle at all times.

6.5 Complete Filtering

- Refill the frypot by pulling the yellow handle to open the oil-return valve (this activates the filter pump automatically).
- After the frypot refills, allow the oil to bubble for 10-15 seconds to ensure evacuation of all oil from the oil return lines. Push in the yellow handle to close the oil-return valve and de-activate the filter pump. Filtration is complete. Filter another frypot or return the fryer to operation.

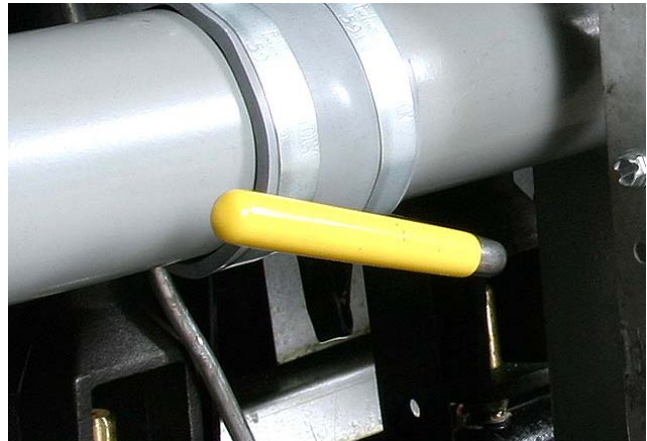

Return filtered oil to the frypot by pulling yellow handle to open oil return valve.

DECATHLON (D & HD) SERIES GAS FRYERS

CHAPTER 7: PREVENTATIVE MAINTENANCE

 **DANGER**

Never attempt to clean the fryer during the cooking process or when the frypot is filled with hot oil/shortening. If water comes in contact with oil/shortening heated to cooking temperature, it will cause spattering of the oil/shortening, which can result in severe burns to nearby personnel.

Any equipment works better and lasts longer when maintained properly and kept clean. Cooking equipment is no exception. The Decathlon Series gas fryer should be kept clean during the working day, and thoroughly cleaned at the end of each day. Below are recommendations for daily, weekly and periodic preventative maintenance.

7.1 Daily

 **WARNING**

Use a commercial grade cleaner formulated to effectively clean and sanitize food-contact surfaces. Read the directions and precautionary statements for use. Particular attention must be paid to the concentration of cleaner and the length of time the cleaner remains on the food-contact surfaces.

- A. Remove and wash all removable parts.
- B. Clean all exterior surfaces of the cabinet. Do not use cleaners, steel wool, or any other abrasive material on stainless steel.
- C. Filter the cooking oil and replace if necessary. The oil should be filtered more frequently when under heavy use.

7.2 Weekly

- A. Completely drain the oil from the fryer into a metal stockpot of sufficient size to safely hold the entire contents of the frypot for disposal. Do not use a glass or plastic container.
- B. Clean the frypot by following boil-out procedures in Chapter 4.2.

 **WARNING**

Never allow water to boil down and expose the heating tubes. Frypot damage will result.

HIGH EFFICIENCY DECATHLON (HD) SERIES GAS FRYERS

CHAPTER 7: PREVENTATIVE MAINTENANCE

7.3 Periodic/ Annual

The fryer should be inspected and adjusted periodically by qualified service personnel as part of a regular kitchen maintenance program.

Frymaster recommends that the fryer be inspected at least annually by a Factory Authorized Servicer as follows:

- Inspect fryer cabinet inside and out, front and rear, for excessive oil build-up and/or oil migration. Verify that burners and associated components (i.e. gas valves, pilot assemblies, igniters, etc.) are in good condition and functioning properly. Inspect all gas connections for leaks and ensure all connections are properly tightened.
- Verify that temperature and high-limit probes are properly connected, tightened and functioning properly.
- Verify all component box components (i.e. computer/controller, relays, transformers, interface boards, etc.) are in good condition and free from oil migration build-up and other debris. Inspect component box wiring and ensure all connections are tight and all wiring is in good condition. Ensure all safety features (i.e. drain safety switches, reset switches, etc.) are present and functioning properly.
- Verify that frypot is in good condition and free of leaks. Verify that frypot tube diffusers are present and in good condition (i.e. no visible deterioration or damage).
- Verify that all wiring and connections are tight and in good condition.

See Chapter 6 for information about filtration.

7.4 Stainless Steel Care



DO NOT let water splash into the tank of hot oil. It will splatter and can cause severe burns.

All stainless steel fryer cabinet parts should be wiped regularly with hot, soapy water during the day, and with a liquid cleanser designed for stainless steel at the end of each day.

- A. Do not use steel wool, abrasive cloths, cleansers or powders.
- B. Do not use a metal knife, spatula or any other metal tool to scrape stainless steel! Scratches are almost impossible to remove.
- C. If it is necessary to scrape the stainless steel to remove any encrusted materials, soak the area first to soften the deposit, then use a wood or nylon scraper only.

DECATHLON (D & HD) SERIES GAS FRYERS

CHAPTER 8: TROUBLESHOOTING

 **DANGER**

Hot shortening will cause severe burns. Never attempt to move this appliance when filled with hot shortening or to transfer hot shortening from one container to another.

 **DANGER**

This equipment should be unplugged when servicing, except when electrical circuit tests are required. Use extreme care when performing such tests.

This appliance may have more than one electrical power supply connection point. Disconnect all power cords before servicing.

Inspection, testing and repair of electrical components should be performed by an authorized servicer only.

The problems and possible solutions covered are those most commonly encountered. To troubleshoot, perform the test set-up at the beginning of each condition. Follow each step in sequence.

8.1 Pilot Burner Malfunction

- A. Pilot will not ignite; no evidence of gas at pilot burner.
 - 1. Check that gas valve is open and gas is present at the gas valve.
 - 2. Check pilot burner orifice for dirt or lint.
 - 3. Authorized Servicer Only: Remove pilot burner gas-supply line and check for contamination; blow out if necessary, then reinstall.
- B. Pilot burner ignites but will not remain lit when gas valve manual knob is released.
 - 1. Check that thermocouple lead is properly screwed into thermocouple connection bushing on gas valve.
 - 2. Remove end of thermocouple lead from thermocouple connection bushing and clean with fine sandpaper or emery cloth.
 - 3. Authorized Servicer Only: Pilot flame may be too high or too low. Adjust pilot flame adjustment screw so that pilot flame extends about 3/4-inch (19-mm) above the top of the pilot burner.
 - 4. Check all connections for cleanliness and security.

HIGH EFFICIENCY DECATHLON (HD) SERIES GAS FRYERS
CHAPTER 8: TROUBLESHOOTING

8.1 Pilot Burner Malfunction (cont.)

- C. Pilot flame of proper size, but is unstable. Flame wavers and does not envelope the thermocouple completely at all times.
- Check for drafts that might be caused by air conditioning equipment or make-up air apparatus. Turn air-moving equipment off and recheck the pilot.

8.2 Main Burner Malfunctions

- A. Main burner will not come "ON"; gas not detected at main burner.
1. Check that the gas valve is open.
 2. Check that the pilot is ignited and is operating properly.
 3. Authorized Servicer Only: Check the high-limit switch for continuity.
 4. Authorized Servicer Only: Check the combination gas valve and replace if defective.
- B. Main burner flames are small and appear lazy; shortening does not come up to temperature quickly.
- Authorized Servicer Only: Check gas pressure at the pressure tap of the gas valve. Use dial type or standard water-type U-gauge manometer. With burner in operation, the pressure should be 4" W.C. for D and HD models utilizing natural gas. The pressure should be 11" W.C. for D models and 10" W.C. for HD models utilizing propane. If not, remove the pressure regulator adjustment cover. Use screwdriver to turn the adjusting screw for proper pressure. Replace cover, re-check pressure and re-install pressure tap plug.
- C. Signs of excessive temperature; shortening scorches and quickly becomes discolored.
1. Check operating thermostat. May be out of adjustment or calibration. Recalibrate if necessary.
 2. Check gas pressure as outlined above.
 3. Shortening used is of inferior quality and/or shortening has been used too long. Replace shortening.
 4. Ensure frypot is clean when refilling with new shortening.

HIGH EFFICIENCY DECATHLON (HD) SERIES GAS FRYERS

CHAPTER 8: TROUBLESHOOTING

8.2 Main Burner Malfunctions (cont.)

- D. Fryer will not reach the temperature setting and/or runs erratically.
 - 1. Incorrect location of sensor probe or defective temperature sensor.
 - 2. Loose wiring/wire connection.
- E. Fryer shortening temperature cannot be controlled; fryer runs at high-limit temperature.
 - 1. Defective operating thermostat or temperature probe; Call Authorized Servicer.

8.3 Electronic Thermostat Controller Calibration

The electronic thermostat controller maintains a specific cooking temperature through a sensing probe mounted in the frypot. If the actual temperature of the shortening varies from the controller dial setting, loosen the knob setscrew and rotate the knob until it agrees with that of the actual shortening temperature. When obtaining actual shortening temperature, ensure that the thermometer is inserted within 1 inch of the frypot-mounted probe. If proper calibration cannot be achieved, contact Authorized Service Agent for repair.







Control knob setscrew location (arrow – counter-set in knob).



Electronic thermostat probe in frypot (arrow).

**WELBILT®**
*Bringing innovation to the table***WWW.WELBILT.COM**

Welbilt provides the world's top chefs, and premier chain operators or growing independents with industry leading equipment and solutions. Our cutting-edge designs and lean manufacturing tactics are powered by deep knowledge, operator insights, and culinary expertise. All of our products are backed by KitchenCare® – our aftermarket, repair, and parts service.

 CLEVELAND
CONVOOTHERM® DELFIELD®
FITKITCHEN™ FRYMASTER®
GARLAND KOLPAK®
LINCOLN MANITOWOC®
MERCO® MERRYCHEF®
MULTIPLEX®