

4" DECKMOUNT FAUCET W/ LEVER HANDLES

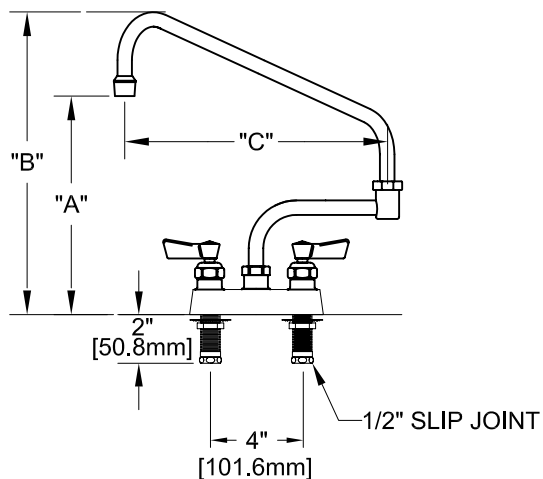

4" DECKMOUNT FAUCET W/ WRIST HANDLES

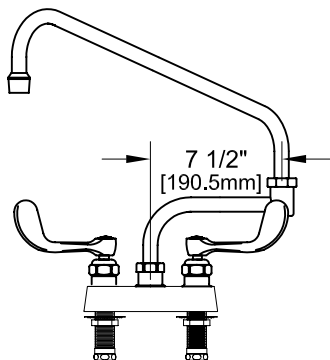

FOOTPRINT:

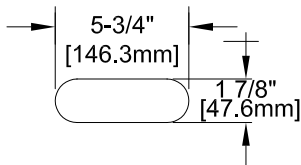

ROUGH-IN:

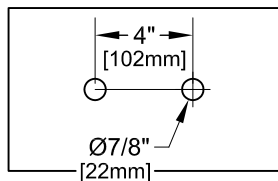

PRODUCT NAME: STAINLESS STEEL  
4" DECK MOUNT FAUCETS

MODEL:

- 53805 W/ 6" SWING SPOUT W/ 7" DJ & LEVER HANDLES
- 53813 W/ 8" SWING SPOUT W/ 7" DJ & LEVER HANDLES
- 53821 W/ 10" SWING SPOUT W/ 7" DJ & LEVER HANDLES
- 53848 W/ 12" SWING SPOUT W/ 7" DJ & LEVER HANDLES
- 53856 W/ 14" SWING SPOUT W/ 7" DJ & LEVER HANDLES
- 53864 W/ 16" SWING SPOUT W/ 7" DJ & LEVER HANDLES
- 58629 W/ 6" SWING SPOUT W/ 7" DJ & WRIST HANDLES
- 58637 W/ 8" SWING SPOUT W/ 7" DJ & WRIST HANDLES
- 58645 W/ 10" SWING SPOUT W/ 7" DJ & WRIST HANDLES
- 58653 W/ 12" SWING SPOUT W/ 7" DJ & WRIST HANDLES
- 58661 W/ 14" SWING SPOUT W/ 7" DJ & WRIST HANDLES
- 58688 W/ 16" SWING SPOUT W/ 7" DJ & WRIST HANDLES

FEATURES

CONTROL VALVE

- \* 4" DECK MOUNT
- \* STAINLESS STEEL CONSTRUCTION
- \* SWIVELLING SEAT DISKS
- \* HOT SIDE STEM - RIGHT HAND
- \* COLD SIDE STEM - LEFT HAND
- \* LEVER HANDLES OR WRIST HANDLES
- \* SWING SPOUT

SYSTEM LIMITS

- \* TEMP: 40°F MIN. TO 140°F MAX.

SHIPPING WEIGHT

- \* 6.0 LBS

\* NSF 61-9 APPROVED & LISTED

[www.truesdail.com](http://www.truesdail.com)

MODELS	DIM "A"	DIM "B"	DIM "C"
53805 58629	5-3/4" [146.05mm]	9-3/8" [244.48mm]	6" [152mm]
53813 58637	6-7/16" [163.51mm]	10-1/16" [255.58mm]	8" [204mm]
53821 58645	7-1/16" [179.38mm]	10-11/16" [271.46mm]	10" [254mm]
53848 58653	7-3/4" [196.85mm]	11-3/8" [295.27mm]	12" [305mm]
53856 58661	8-5/16" [211mm]	11-15/16" [303.21mm]	14" [356mm]
53864 58688	9" [228.6mm]	12-9/16" [319.08mm]	16" [406mm]

**FISHER**

FISHER MANUFACTURING COMPANY

TOLL FREE: 800-421-6162 - FAX: 800-832-8238

[information@fisher-mfg.com](mailto:information@fisher-mfg.com) - [www.fisher-mfg.com](http://www.fisher-mfg.com)