

Semi Automatic Divider Rounder

MODEL: DSA354



Shown in Standard Epoxy Coat & Stainless Steel

FEATURES & BENEFITS

- 54 Portion Cutting Head with (3) Sanitary Rounding Plates
- Recommended for Dough Absorption Ratio: 55 - 65%
- Lubrication Free Shafts
- Belt Driven Transmission
- Heavy Duty Low Profile Casters for Mobility
- Feet in AISI304 Stainless Steel - prevents rusting
- Knives in AISI304 Stainless Steel
- Easy to clean & maintain - no tools required
- Interchangeable Head Piece (Requires Additional Head—Sold Separately)
- Adjustable Portion Size between 0.5 oz to 1.6 oz (15 - 45 grams)

OPTIONS & ACCESSORIES

- Stainless Steel Construction (Suffix I)
- Additional Dough Plates (EA)
- 15 Portion Divider Head with Plates (DSAH15)
- 22 Portion Divider Head with Plates (DSAH22)
- 30 Portion Divider Head with Plates (DSAH30)
- 36 Portion Divider Head with Plates (DSAH36)
- International Electrical Configuration (208-240V)

STANDARD PRODUCT WARRANTY

One Year Labor & Two Year Parts

FINISH

Epoxy Painted Galvanized Carbon Steel

DIMENSIONS & SHIPPING WEIGHT

24 7/16" W X 26" D X 52 3/8" H
(621 mm X 660 mm X 1330 mm)
850lb (386 kg)

ELECTRICAL SYSTEM

1 Phase (Ground Wire not Included):

- 120 V - 8 A - 0.96 kW - 60 Hz - Nema 5-15P
- 208 V - 4.6 A - 0.96 kW - 50/60 Hz - 2 Wires + Ground
- 240 V - 4 A - 0.96 kW - 50/60 Hz - 2 Wires + Ground

DRAWINGS

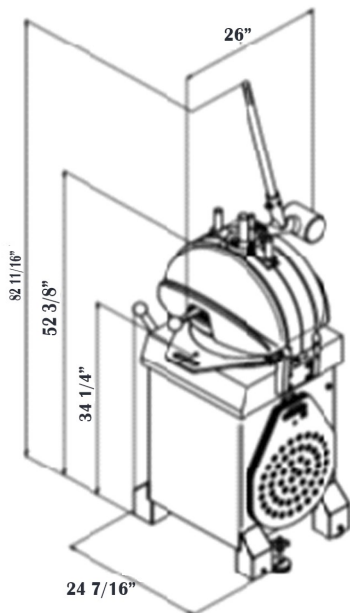

SHORT SPECIFICATION

Divider Rounder, Semi Automatic, Electric, Epoxy Painted Galvanized Carbon Steel Frame, 54 Portion Dividing Head with Plates, Belt Driven Transmission, Interchangeable Head, One Year Labor & Two Year Parts Warranty